

# AgriAlert 800 & 800T

## ALARM SYSTEM INSTALLATION MANUAL

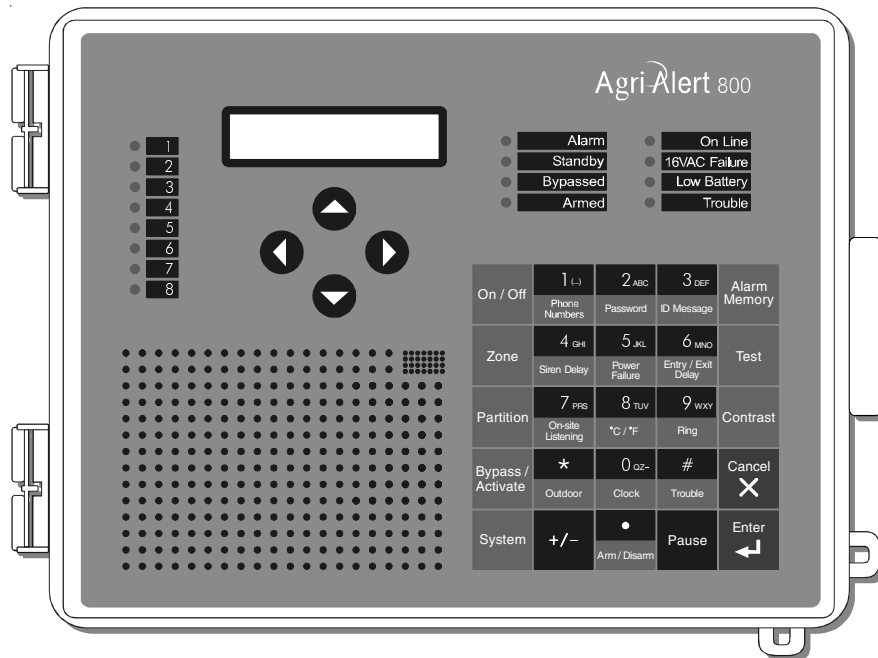

Manufacturer:



**VIATRON**

ELECTRONIQUE • ELECTRONICS

Viatron Electronics  
5200, Armand-Frappier  
St-Hubert (Quebec)  
Canada  
J3Z 1G5

## WARNINGS

The warranty can be void if this product is used in a manner not specified by the manufacturer.

Every effort has been made to ensure that this manual is complete, accurate and up-to-date. The information contained in it is however subject to change without notice due to further developments.

# Table of Contents

<b>CHAPTER ONE: INSTALLATION</b> .....	<b>6</b>
1.1 INSTALLATION PROCEDURE .....	6
1.2 MOUNTING THE EQUIPMENT .....	7
1.3 CONNECTING THE EQUIPMENT .....	9
1.3.1 <i>Sensors</i> .....	9
1.3.2 <i>Supply Inputs</i> .....	10
1.3.2.1 <i>AC Power Connection</i> .....	10
1.3.2.2 <i>Backup Battery Connection</i> .....	10
1.3.3 <i>Terminal Outputs</i> .....	10
1.3.3.1 <i>Siren Output</i> .....	10
1.3.3.2 <i>12VDC Output (AA 800T only)</i> .....	10
1.3.4 <i>Phone Hookup</i> .....	11
1.3.5 <i>Connecting the Earth Ground</i> .....	12
<b>CHAPTER TWO: USER INTERFACE</b> .....	<b>13</b>
2.1 FRONT PANEL .....	13
2.2 MEANING OF STATUS LEDS .....	14
2.3 DISPLAYING A PARAMETER .....	14
2.4 MODIFYING A PARAMETER .....	15
2.5 HOW TO USE THE MENUS .....	16
<b>CHAPTER THREE: SYSTEM INITIALIZATION</b> .....	<b>17</b>
3.1 INSTALLER PASSWORD .....	17
3.2 CONFIGURING THE ZONES .....	18
3.2.1 <i>Dry Contact Input</i> .....	21
3.2.2 <i>Dry Contact Burglar Input</i> .....	24
3.2.3 <i>Temperature Input</i> .....	26
3.2.4 <i>Pulse Count Input</i> .....	28
3.2.5 <i>Setting the Reset Time</i> .....	31
3.2.6 <i>Disable the Siren</i> .....	33
3.3 SYSTEM CLOCK .....	34
3.4 USER ID MESSAGE .....	35
3.5 TEMPERATURE UNITS .....	36
3.6 DISPLAY CONTRAST .....	37
3.7 DEFAULT VALUES .....	38
3.8 TEST PROCEDURE .....	41
3.9 TROUBLE INFORMATION .....	41
3.10 VIEWING SOFTWARE VERSION .....	42
3.11 STANDBY MODE .....	43
<b>CHAPTER FOUR: COMMUNICATION PARAMETERS</b> .....	<b>44</b>
4.1 DIALING INFORMATION .....	44
4.1.1 <i>Dialing Mode and Speed</i> .....	45
4.1.1.1 <i>Dialing Mode</i> .....	45

4.1.1.2	<i>Tone Dialing Speed</i> .....	46
4.1.1.3	<i>Pulse Dialing Speed</i> .....	47
4.1.2	<i>Line Seizure</i> .....	50
4.1.3	<i>Call Repetitions</i> .....	51
4.1.4	<i>Message Repetitions</i> .....	52
4.1.5	<i>Busy Line Tries</i> .....	53
4.1.6	<i>Tone Delay</i> .....	54
4.1.7	<i>Pause Delay Key</i> .....	55
4.1.8	<i>Call Start Delay</i> .....	56
4.1.9	<i>Time Between Calls</i> .....	57
4.1.10	<i>Alarm Recall Time</i> .....	58
4.1.11	<i>Restore Calls</i> .....	59
4.1.12	<i>Disable the Dialer</i> .....	60
4.2	PHONE NUMBERS .....	61
4.3	ON SITE LISTENING .....	65
4.4	RINGS / ANSWERING MACHINE .....	66
4.5	SYSTEM'S VOICE MUTE .....	67
<b>CHAPTER FIVE: ALARM PARAMETERS</b> .....		<b>69</b>
5.1	ALARM VALIDATION: SUMMARY OF EVENTS .....	69
5.2	SYSTEM ALARMS .....	70
5.2.1	<i>Backup Battery Voltage Readout</i> .....	70
5.3	OUTDOOR TEMPERATURE COMPENSATION ON TEMPERATURE ALARMS .....	72
5.4	ALARM MEMORY .....	77
5.5	ZONE STATUS DISPLAY .....	78
5.5.1	<i>Viewing and Modifying Dry Contact Zones</i> .....	78
5.5.2	<i>Viewing and Modifying Temperature Zones</i> .....	79
5.5.3	<i>Viewing and Modifying Pulse Count Zones</i> .....	82
5.6	PARTITIONS .....	84
5.7	BYPASS / ACTIVATE FUNCTION .....	86
5.8	ENTRY DELAY .....	88
5.9	EXIT DELAY .....	89
5.10	SIREN DELAY .....	90
<b>TROUBLESHOOTING GUIDE</b> .....		<b>91</b>
<b>APPENDIX A: FUSE TYPES</b> .....		<b>93</b>
<b>APPENDIX B: MAXIMUM WIRE LENGTHS</b> .....		<b>93</b>
<b>APPENDIX C: BACKUP BATTERY LIFE SPAN</b> .....		<b>93</b>
<b>GLOSSARY OF TERMS</b> .....		<b>94</b>
<b>WIRING DIAGRAMS</b> .....		<b>96</b>
<b>TECHNICAL SPECIFICATIONS</b> .....		<b>97</b>
<b>REGISTRATION CARD</b> .....		<b>99</b>

## LIST OF TABLES AND FIGURES

Figure 1: Mounting the Enclosures .....	7
Figure 2: Location of Mounting Holes .....	8
Figure 3: Electrical Knockouts for Battery Hookup .....	9
Figure 4: Phone Hookup with Line Seizure .....	11
Figure 5: Phone Hookup without Line Seizure .....	11
Figure 6: Illustration of Recognition Time .....	19
Figure 7: Normally Open Circuits With EOLR .....	21
Figure 8: Examples of Zone Connections Without EOLR .....	21
Figure 9: Examples of Zone Connections with EOLR .....	22
Figure 10: Temperature Input .....	26
Figure 11: Illustration of Reset Time .....	31
Figure 12: Pulse Timing Parameters .....	45
Figure 13: Waiting Time .....	54
Figure 14: Calling a Pager Number .....	64
Figure 15: Outdoor Temperature Compensation .....	72
Figure 16: Critical Temperature Monitoring .....	73
Figure 17: Monitoring the Indoor-Outdoor Temperature Differences .....	73
Figure 18: Example of Partitioning .....	84
Table 1: Default Values .....	39
Table 2: Pager Codes Used by the Agri-Alert System .....	63
Table 3: System Alarms .....	70

### NOTICE

Every effort has been made to ensure that this manual is complete, accurate and up-to-date. The information contained in it is however subject to change without notice due to further developments.

# CHAPTER ONE: INSTALLATION



## 1.1 INSTALLATION PROCEDURE

What You Need:- Agri-Alert system including independent battery enclosure

- 12VDC / 7.5AH sealed lead acid battery
- 16.5VAC/40VA transformer



**TO AVOID ELECTRICAL SHOCKS AND EQUIPMENT DAMAGE, TURN OFF THE BREAKER ON WHICH IS CONNECTED THE UNIT BEFORE CONFIGURING THE MAIN BOARD OR MAKING CONNECTIONS TO THE TERMINALS.**

- o **Step 1:** Determine where you want to install the system. You need an unswitched AC power outlet and a telephone plug nearby to operate the system.
- o **Step 2:** Make a list of all the sensor inputs you will be using with the Agri-Alert system.
- o **Step 3:** Mount the Agri-Alert system and the battery enclosure on the wall (see Section 1.2).
- o **Step 4:** Connect a ground wire to the main ground of the system (see Section 1.3.5).
- o **Step 5:** Hook up the sensors, the telephone line and the siren (if used) to the terminals on the main board in the Agri-Alert enclosure (see Section 1.3).
- o **Step 6:** Hook up the battery (see 1.3.2.2) and plug the transformer into an AC power outlet.

### KEYS TO SYMBOLS IN THE MANUAL



Caution. Carefully read the following text for it contains important information which, if ignored, may cause the controller to operate improperly.



Pay attention. The following text contains very useful information.

## 1.2 MOUNTING THE EQUIPMENT

The Agri-Alert system should be mounted on a wall as shown in the figure below. The Agri-Alert enclosure is opened by sliding the latch upwards and pulling. The battery enclosure is opened by pulling on the latch. Use 3/16" diameter screws to mount each enclosure on the wall. Fasten the black caps onto the mounting holes once the screws are tightened. Make sure the covers of the two boxes can be opened easily. The battery enclosure has ventilation openings on the sides. Make sure they are not obstructed. Mount the battery enclosure 4" from the Agri-Alert enclosure. Use the plastic tubing provided to run the wires from the battery to the alarm system. These wires are provided with the system. The bare end hooks up to the Agri-Alert system. Electrical knockouts are located on the bottom of each enclosure for running the tube. Use a screwdriver and a hammer to punch out the holes. Use the cable holders provided to connect the tube to the enclosure. This prevents water from seeping into the enclosure.

Figure 1: Mounting the Enclosures

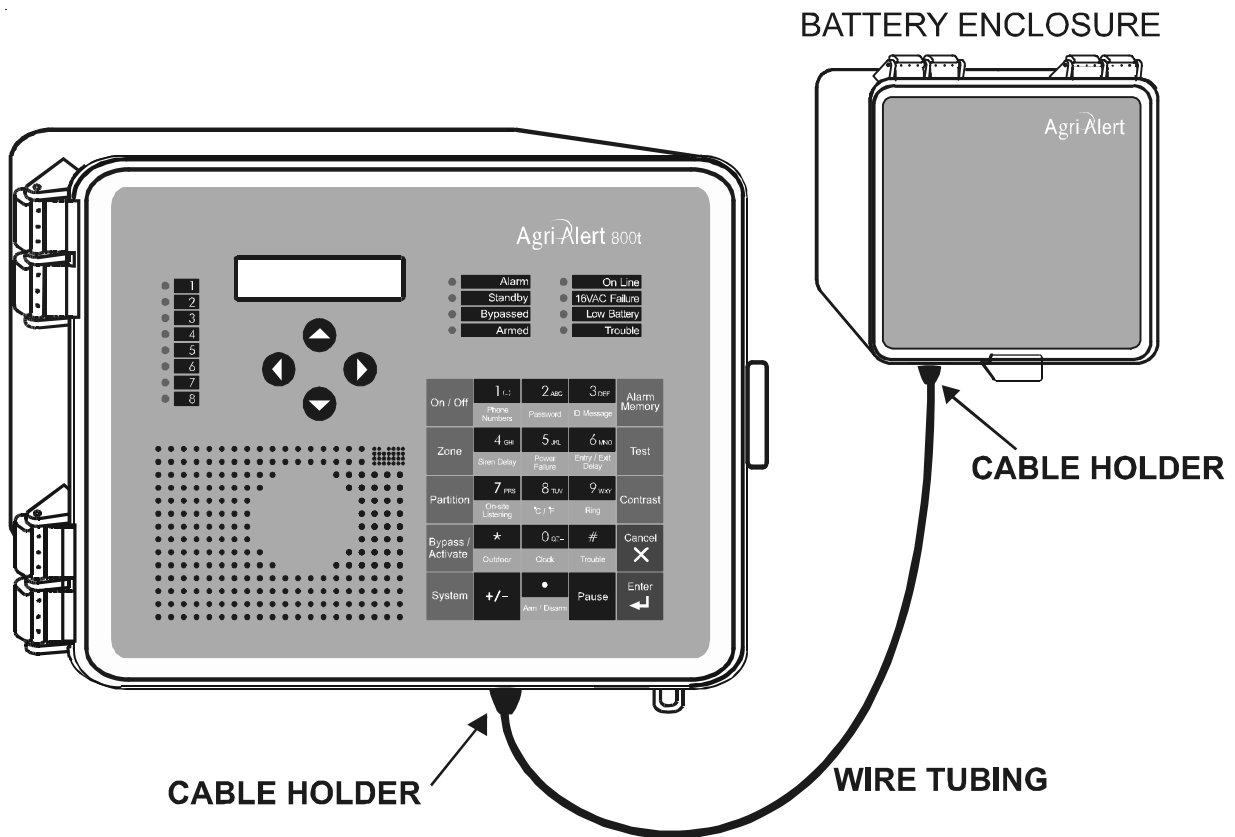



IF OUTDOOR CONNECTIONS ARE USED, MOUNT THE ENCLOSURE AS CLOSE AS POSSIBLE TO THE ENTRY POINT OF THE OUTDOOR WIRING.

Figure 2: Location of Mounting Holes

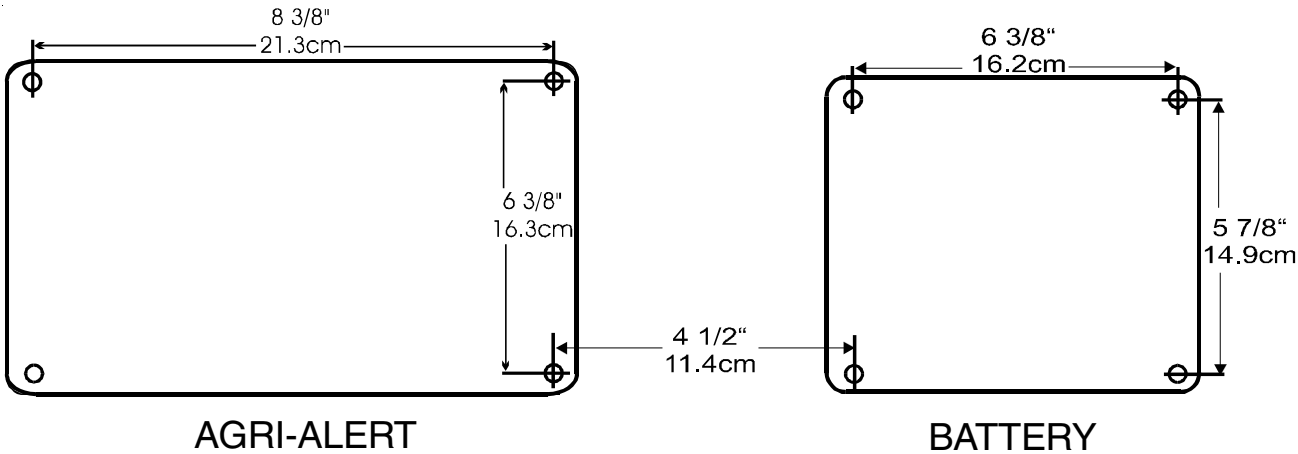



**Figure 3: Electrical Knockouts for Battery Hookup**

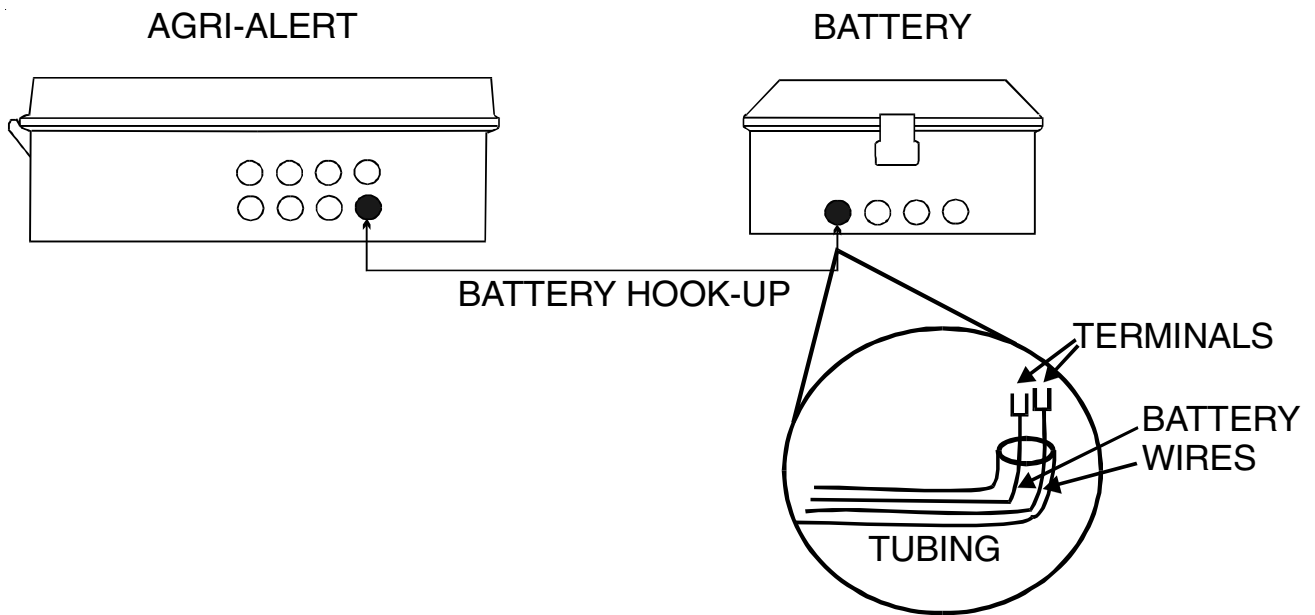

### 1.3 CONNECTING THE EQUIPMENT

When connecting the equipment to the terminals provided on the main board and the extension cards, strip the wires as little as possible (about 1/4") to avoid electrical shorts. Avoid running wires too close to the heat sink (H5 and H6). Once the wires are connected, run them through the electrical knockouts provided on the bottom of the Agri-Alert enclosure and use a cable holder (2 cable holders are provided for the battery connections and 2 additional cable holders are included with the system – you can order additional cable holders from your dealer if needed). Additional holes made in the enclosure will void the warranty.

#### 1.3.1 Sensors

The terminals used for sensor inputs are numbered Z1, Z2, Z3, etc. on the main board. Connect each sensor to a Z terminal and to the ground terminal (GND). Note that each ground terminal is used by two zones; for example, Z1 and Z2 use the same ground. Make sure each sensor is connected to the proper ground. False alarms can result if the ground wires are not properly connected.

#### Sensor Inputs on the Main Board:

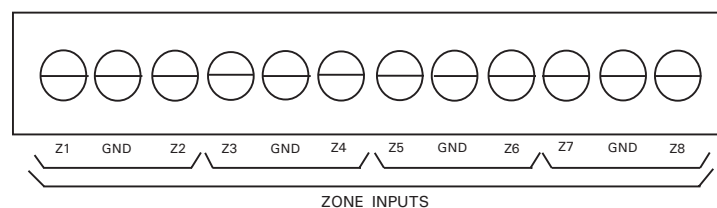

## 1.3.2 Supply Inputs

### 1.3.2.1 AC Power Connection

The terminals marked 16VAC on the main board are used for connecting the transformer. The transformer provided with the system is a 16.5VAC/40VA transformer. It must be plugged into a 120VAC/60Hz outlet. The F6 and F7 fuses (5A fast blow) are connected to this input. Make sure the power source is unswitched (i.e. there is no switch on the power outlet).

### 1.3.2.2 Backup Battery Connection

The terminals marked BATTERY are used for the backup battery. The Agri-Alert system uses a 12VDC / 7.5AH sealed lead acid battery. No other type of battery can be used. The F28 fuse (5A slow blow) is connected to this input. The battery wires run through the tube provided, as shown in Figure 3. Make sure the positive wire of the battery is connected to the positive terminal. See Appendix C for normal battery life spans.

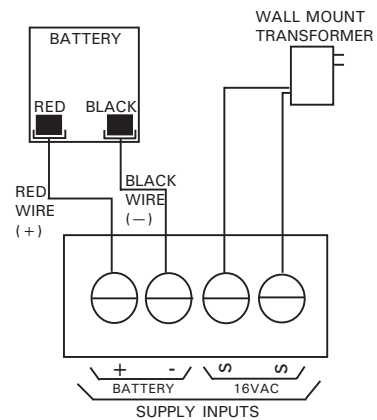

## 1.3.3 Terminal Outputs

### 1.3.3.1 Siren Output

The terminals marked SIREN are for the siren. The voltage supplied is 12VDC with a maximum current of 1.5A. Note that the battery must be hooked up if a siren is used. The F8 fuse (2A slow blow) is connected to this output. Make sure the positive wire is connected to the positive terminal of the siren. The siren circuit is monitored by the Agri-Alert system for defects and wire troubles. This may not work properly if the impedance of the siren is too high. If this is the case, you can add a 1.5k $\Omega$  resistor (1/2W) to the siren circuit as close to the siren as possible. If no siren is connected, a 1.5k $\Omega$  resistor (1/2W) (included with the system) must be wired to the siren output.

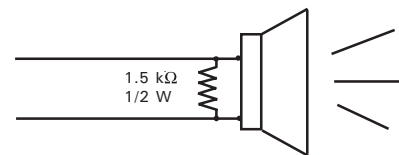

### 1.3.3.2 12VDC Output (AA 800T only)

The terminals marked 12VDC provide 12VDC with a maximum current of 750mA. This can be used to power other accessories such as temperature controllers. The F4 fuse (1A fast blow) is connected to this output. In the event of a power failure, the battery back-up provides 12VDC to this line. Make sure the positive wire is connected to the positive terminal of your device.

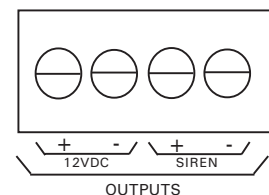

### 1.3.4 Phone Hookup

Two types of phone hookups are possible. In the simplest case, the Agri-Alert is connected to the phone lines using an ordinary 6 contact phone jack (Canada: CA11; USA: RJ11). The two wires from the phone line are connected to the LINE terminals marked R and T. In this configuration, the user has priority over the system when using the phone line: the system will wait for the line to free up before dialing out.

The best method is to use a line seizure modular jack designed for use with alarm systems (Canada: CA31A or CA38A; USA: RJ31A or RJ38A). In this case, the system has priority over other users when dialing out. A line seizure kit is available from your dealer (part number 70-10212). The connections for this type of plug are shown in the figure below. This plug disconnects all other phones on the line when dialing out in an emergency. In order to do this, you must tap the phone line at its point of entry in the building.

**Figure 4: Phone Hookup with Line Seizure**

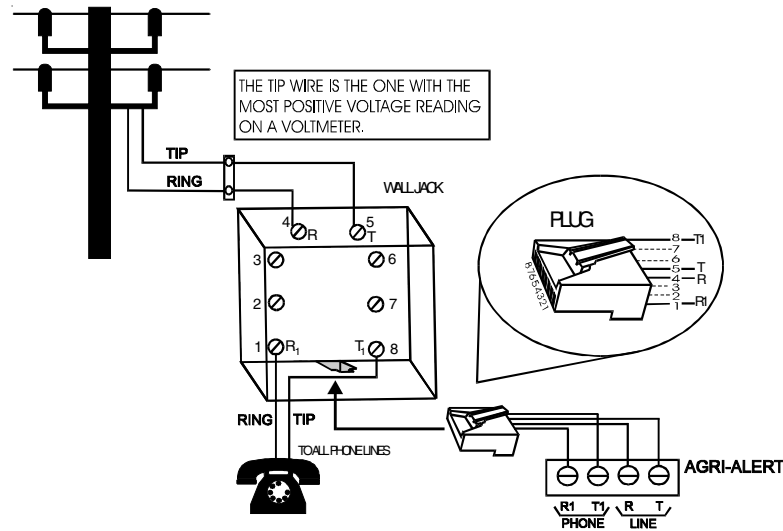

**Figure 5: Phone Hookup without Line Seizure**

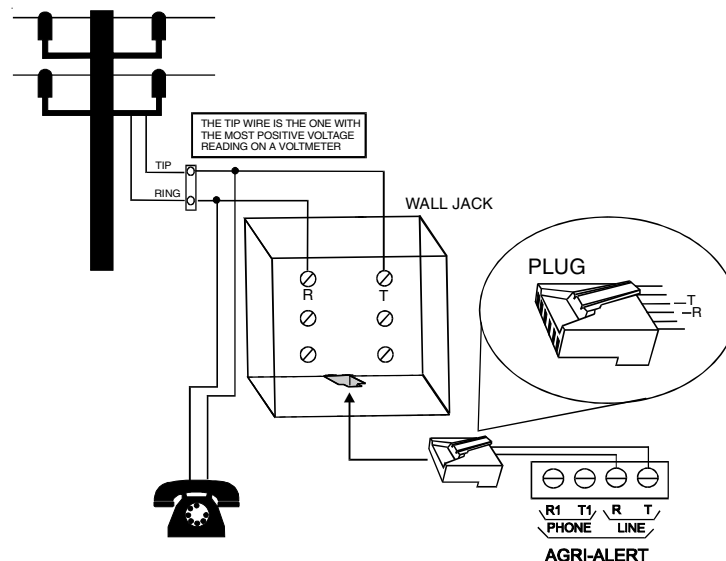

### 1.3.5 Connecting the Earth Ground

The earth ground terminal provides a ground for the Agri-Alert system. Use a rod at least 5/8" (1.6cm) in diameter at least 10' (3m) long. The rod must have a clean metal surface free of paint, enamel or other non-conducting substances. Drive the rod at least 10' (3m) into the ground. If the bedrock is more than 47" (1.2m) deep, drive the rod into the ground to bedrock level and bury any remainder horizontally at least 2' (600mm) below ground level. If the bedrock is less than 47" (1.2m) deep, bury the rod horizontally at least 2' (600 mm) below ground level.

(ref. article 10-702, 3d of the Canadian Electricity Code C22.10-99)

Use a CSA certified wire of TEW type or a UL certified wire of type 1015: Green/yellow, #12AWG, 600V, 105°C insulated wire. We suggest using a Belden #9912 (color code #189) or equivalent.

The rod must be connected to the wire described above. It is recommended to let the rod going out of the ground to connect it. The rod length must not exceed 50' (15m).



It is extremely important that the earth ground terminal be connected to a proper ground to protect the electronic components from damage due to lightning surges and electrostatic discharges. Do not use the electrical ground for this purpose.



**IF OUTDOOR CONNECTIONS ARE USED, MOUNT THE ENCLOSURE AS CLOSE AS POSSIBLE TO THE ENTRY POINT OF THE OUTDOOR WIRING.**



**AN IMPROPER EARTH GROUND CONNECTION IMMEDIATELY VOIDS THE SYSTEM WARRANTY WITHOUT FURTHER NOTICE.**

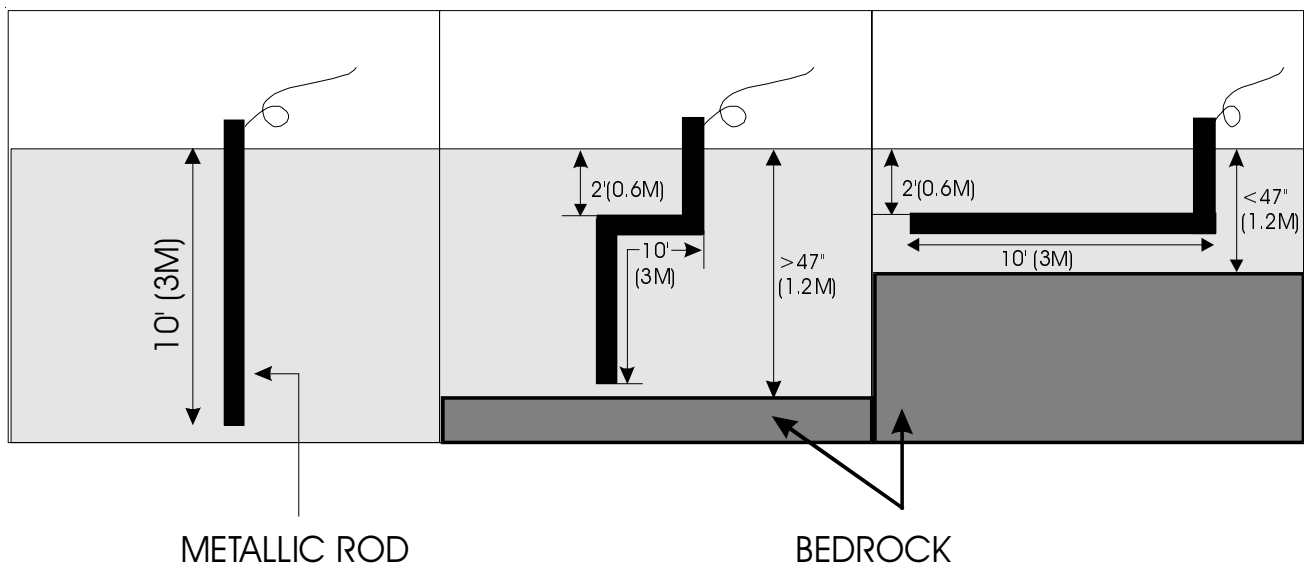

## CHAPTER TWO: USER INTERFACE

The system displays and prompts for information by using the alphanumeric screen. The keypad is used for data entry and for enabling and disabling the various system functions. The speaker on the front panel delivers voice messages. A built-in piezo-electric warns of illegal entries (3 short beeps) and beeps once when a valid key is pressed. The integrated microphone on the front panel is used to record the user ID message and provide on-site listening. The status of some subsystems is displayed using LEDs on the front panel.

### 2.1 FRONT PANEL

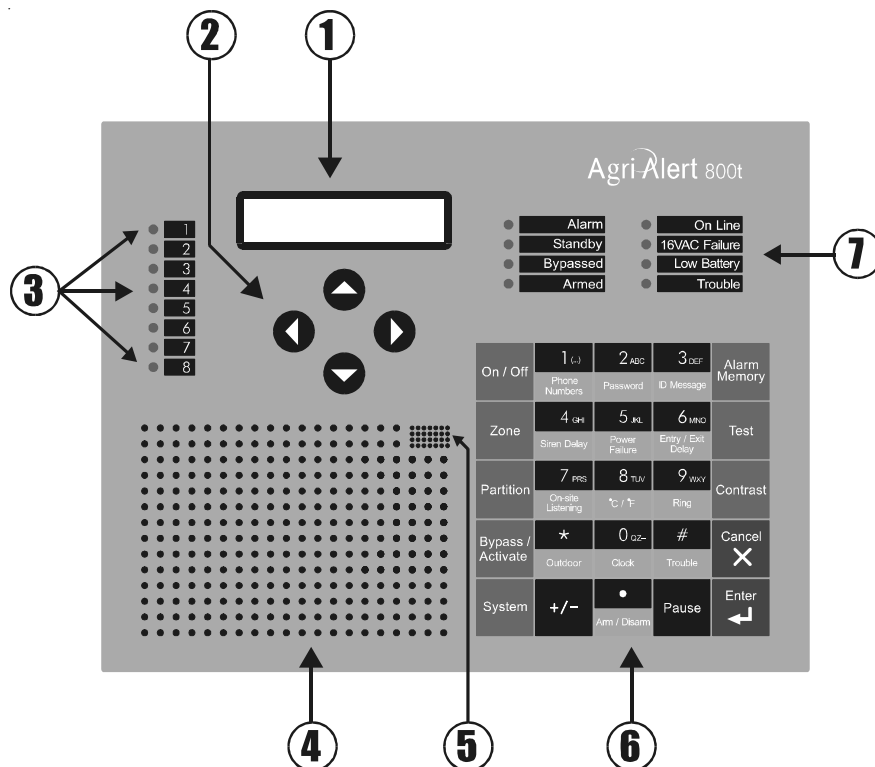

**1 - Display Screen** — An alphanumeric display used to provide information and prompt for inputs.

**2 - Cursor Keys** — Used to step through menu items during data entry and for deleting the last character entered.

**3 - Zone Status LEDs** — Off: DISABLED; On: ACTIVATED; Slow Blinking: BYPASSED; Fast Blinking: ALARM.

**4 - Speaker** — System identification and alarm messages.

**5 - Integrated Microphone** — Records the ID message and provides on-site listening input.

**6 - Keypad** — User inputs and information requests.

**7 - System LEDs** — Status of various subsystems (see table on following page).

## 2.2 MEANING OF STATUS LEDS

LED	MEANING
ALARM	This LED is activated when one or more alarm conditions are detected. The individual zone LEDs on the left side of the panel corresponding to the zones in alarm start blinking at high speed. The LED is turned off when the alarm is acknowledged as long as the alarm condition no longer exists, the reset time has elapsed and no other alarms are active.
STANDBY	This LED is activated when the Agri-Alert system is in standby mode. In this mode, the system stops monitoring the sensor inputs for alarm conditions. The LED is turned off when normal monitoring is resumed.
BYPASSED	This LED is activated when one or more zones are bypassed. The individual zone LEDs on the left side of the panel corresponding to the bypassed zones start blinking at low speed. The LED is turned off when no zones are currently bypassed.
ARMED	This LED is activated when the burglar zone is armed.
ON LINE	This LED is activated when the system uses the phone line.
16 VAC FAILURE	This LED is activated when a power failure is detected on the 16VAC supply circuit (wall mount transformer).
LOW BATTERY	This LED is activated when the back-up battery voltage is low.
TROUBLE	This LED is activated when: <ul style="list-style-type: none"> <li>- a zone configuration conflicts with the signal received from the sensor</li> <li>- a wire short or open circuit is detected on a temperature or dry contact with EOLR input.</li> <li>- a software problem is detected.</li> </ul>

## 2.3 DISPLAYING A PARAMETER

When you select a parameter to input or modify, the system begins by displaying the current value or status of the parameter. If the message to display is longer than the size of the window, it will be scrolled to the left. The display pauses at the end of each screen to allow time to read the message. You can exit prematurely from a display sequence at any time by pressing the **Cancel**  key. This will place you in program mode and allow you to modify the parameter values (see next section). To exit from this function as well, press the **Cancel** key once again. If a parameter is not completely defined when you try to display it, the message **INCOMPLETE DATA** appears on the screen. This may be an indication that the system will not behave as expected. If, for example, a zone input is not completely configured, the system will

not monitor the zone for alarm conditions. Before enabling the system for normal operation, make sure all parameters are properly defined. In the case of phone numbers and zones, the system will display a message every 3 seconds telling the user which zones and phone numbers are incomplete. To exit from the warning display, press the **Cancel** key.

## 2.4 MODIFYING A PARAMETER

If you have selected a parameter and the display sequence is now finished, you can begin modifying the parameter values. The following screen appears on the display:



```
TO MODIFY. . . . . (↵)
TO QUIT. . . . . (X)
```

This screen is also displayed if the display sequence described above was cancelled prematurely. If you want to modify the parameter values at this point, press the **Enter** key  to modify the parameter. The system will prompt for the information required to define the parameter. When the parameter is defined by a numerical value, a range of possible values is displayed. For example, if you select the Exit Delay parameter followed by **MODIFY**, the system responds:

```
RANGE FROM
(0 .. 5 MIN, 0 .. 59 SEC)
```

```
ENTER NEW DELAY
_ MIN: __ SEC
```

The number of spaces provided for input corresponds to the maximum number of digits allowed. In this example, one space is provided for the minutes and 2 spaces are provided for the seconds. The cursor positions itself on the first space and blinks until a digit is entered. If no response is given within 2 minutes, the system will cancel the input session and return to the Date/Time display. If more than one value is required in the same screen (in this example: hours and minutes), press **Enter** after entering the first value to step to the following one. To enter a zero value, you cannot simply press **Enter**; you must type **0 Enter**.



If you make a typing mistake, you can backstep using the back arrow key  underneath the display window before pressing **Enter**. The cursor will position itself accordingly. You can enter a negative value if this is allowed (for example, a negative temperature value) by pressing the +/- key  either before or after the digits.

After entering a value using the numerical keypad, press **Enter** to register the value. If the value entered falls outside the permissible range for that parameter, the system will beep three times and wait for you to modify the input using the back arrow key.

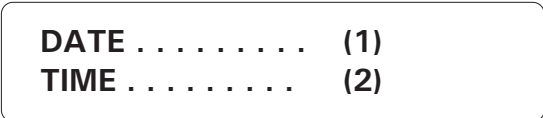

## 2.5 HOW TO USE THE MENUS

Menus are used to select a parameter or to assign a predetermined value to a parameter. If the menu is comprised of only two items, they are displayed on the screen at once. For example, when you press the **Clock** key , followed by **Enter** to modify, the following menu appears:



You simply type the number of the item to select that item (no need to press the **Enter** key). When more than two menu items are involved, the system will display one item at a time and allow the user to scroll through the menu using the up and down-arrow keys  . Each menu item is followed by an arrow symbol to locate the current position in the menu. Once a menu item is selected, other sub-menus may appear to further define the input. For example, if you press the **Password** key , after having entered the master's password, the following sub-menu appears:



The first menu item is **STATUS**. The arrow following the item means you are at the top of the menu. If you press the down-arrow , the second item appears: The arrows indicate that menu items are to be found above and below the current item. When you reach the end of the menu, the last item will have an up-arrow . To select a menu item, press **Enter**.





## CHAPTER THREE: SYSTEM INITIALIZATION

### 3.1 INSTALLER PASSWORD

The system uses a special installer password to restrict access to certain initialization functions. This password must be entered when the SYSTEM menu is selected. By default, the installer password is set to 0801.

To change the installer password:

1. Press the **System** key . The current revision number of the software program is displayed. The installer's password must be entered.

**SOFTWARE**  
REV. x.xxx

**ENTER INSTALLER  
PASSWORD: \_ \_ \_ \_**

2. Enter the installer's password (0801 by default) and press **Enter** .

**SYSTEM  
PROGRAM AUX'S ▲**

3. Using the up and down-arrow keys  , scroll the menu until the item displayed is PRORGRAM AUX'S and press **Enter** .

**PROGRAM AUX'S  
INST. PASSWORD ◆**

4. Using the up and down-arrow keys  , scroll the menu until the item displayed is INST. PASSWORD and press **Enter** .

**ENTER NEW  
PASSWORD: \_ \_ \_ \_**

5. Enter a four-digit code and press **Enter** . The system prompts for the password a second time.

**ENTER AGAIN:**

-----

6. Re-enter the four-digit code and press **Enter**  . The system saves the new password and returns to the Program Aux's scrolling menu.

### 3.2 CONFIGURING THE ZONES

The Agri-Alert system is a monitoring device used to detect alarm conditions. Different types of sensors can be connected to it. When an alarm is detected on any one of the inputs, the system reports the alarm on-site and starts the dialout sequence. Each alarm input can be enabled or disabled separately or in conjunction with other inputs. An alarm stays active until it is acknowledged by a user, either on-site or over the phone. When an alarm occurs, the system stores all the relevant information: the number of the input, the type of alarm and the date and time of occurrence. When the alarm is acknowledged, the system also stores the user who acknowledged the alarm and the date and time of acknowledgement.

**Zone Definition:** A zone is an input configured to respond to the type of sensor connected to it. Sensors are installed by the user to detect alarm conditions. The Agri-Alert system allows up to 8 different zones. The alarm types supported are dry contact, dry contact burglar, temperature and pulse count. A reset time is defined for all zones. The other parameters apply to each individual zone, i.e. the recognition time, the siren enable and the dialout sequence enable. The recognition time does not apply to dry contact burglar zones. In the case of a pulse count alarm, the recognition time is replaced by a high and low set point and an observation length. If any one of these parameters is not entered when a zone is configured, the system will display **INCOMPLETE DATA** whenever the parameter definitions are displayed for that zone. Note that when you reconfigure a zone, the system erases the alarm memory for all zones. Once a zone is configured, it must be activated by the user to start alarm detection on that zone. The following parameters are used for defining zones:

**Recognition Time:** This is the time an alarm input must be active before it constitutes a valid alarm condition. It is used to configure all alarm inputs except pulse count and burglar inputs. Figure 6 below illustrates this. At "A", an alarm situation occurs when the temperature exceeds the high set point. At "B", the temperature returns to normal. However, only 5 seconds have elapsed and the recognition time is 10 seconds. Therefore, no alarm occurs. At "C", a new alarm situation occurs. At "D", (22 - 12) = 10 seconds have elapsed; the recognition time has elapsed and an alarm is reported. The recognition time ranges from 0 to 59 hours, 0 to 59 minutes, 0 to 59 seconds. The default is 1 minute on zones 1-8.

**Figure 6: Illustration of Recognition Time**

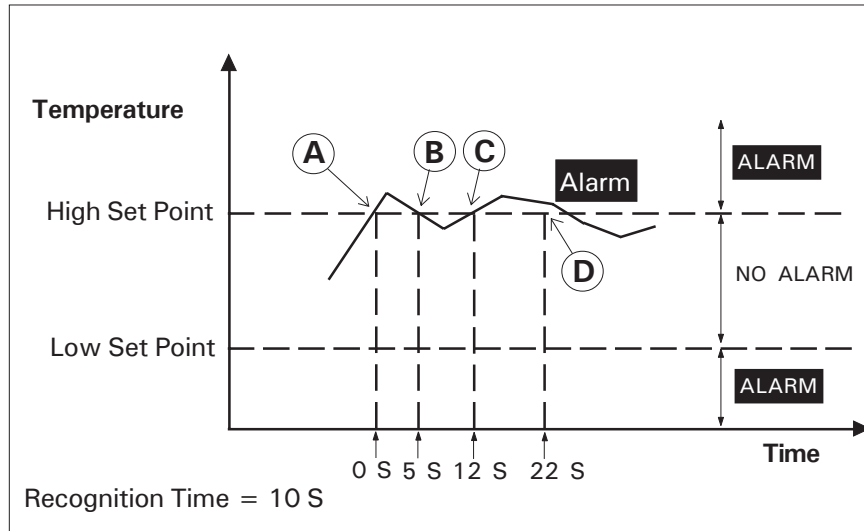

### CONFIGURING THE ZONES

1. Press the **System** key . The current revision number of the software program is displayed. The installer password must then be entered.

**SOFTWARE**  
REV. x.xxx

**ENTER INSTALLER  
PASSWORD: \_ \_ \_ \_**

2. Enter the installer password (0801 by default) and press **Enter** .

**SYSTEM**  
**PROGRAM ZONES** ▼

3. Press **Enter**  once again to select PROGRAM ZONES.



**SELECT ZONE**  
**(1 .. 8): \_**

4. Type the number of the zone to define or modify and press **Enter**. The current definitions for this zone are displayed. Default settings for zones are given in Section 3.7. To exit the display function, press **Cancel**.

TO MODIFY . . . . . (↵)  
TO QUIT . . . . . (X)

5. Press **Enter** to modify the zone or **Cancel** to exit this function. If the zone selected is the outdoor probe used for the outdoor temperature compensation feature and the compensation feature is currently enabled, the system displays the message: **DEACTIVATE OUTDOOR STATUS**. If you want to use the compensation feature, you will have to assign another probe as the outdoor probe (See Section 5.3). The system beeps four times and displays the message: **WARNING! ALARM MEMORY WILL BE LOST!** Each time a zone is reconfigured, the alarm memory associated with all zone configurations is erased.

TYPE OF SENSOR  
DRY CONTACT? ▼

The different types of sensors are presented in a scrolling menu. Use the up and down arrow keys   to select the desired type and press **Enter** .

The following sections describe the input sequence for each of the sensor types.

### 3.2.1 Dry Contact Input

**Definition:** Dry contacts can be either normally open (NO) or normally closed (NC) circuits. In addition, they can be configured for an end of line resistor (EOLR). Adding an end of line resistor will help the system detect wiring problems. This is illustrated in the figure below. In the center diagram, an open wire has occurred. The system detects this by reading the resistance on the circuit. The “Trouble” LED on the front panel will turn on when this happens. Figure 7 shows three possible states for a normally open circuit with EOLR. Figures 8 and 9 show examples of zone connections. Note that when you add an EOLR to a circuit, the resistor must be connected to the sensor that is furthest from the Agri-Alert system.

**Figure 7: Normally Open Circuits With EOLR**

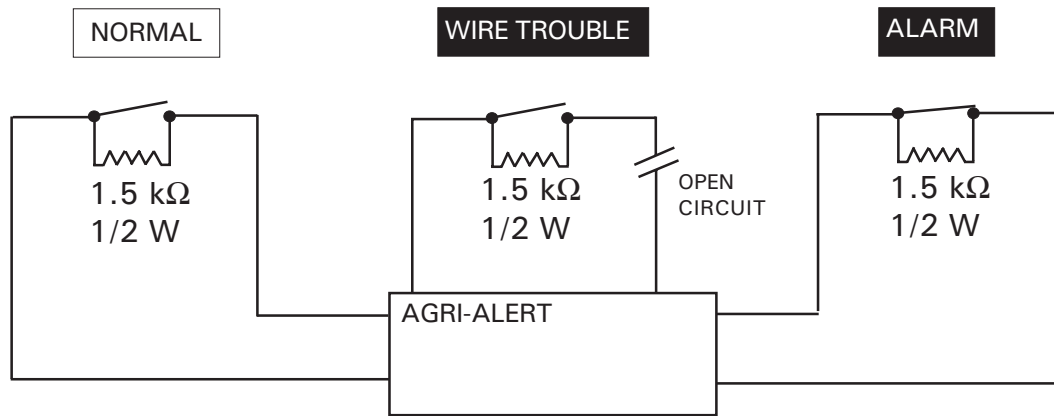

**Figure 8: Examples of Zone Connections Without EOLR**

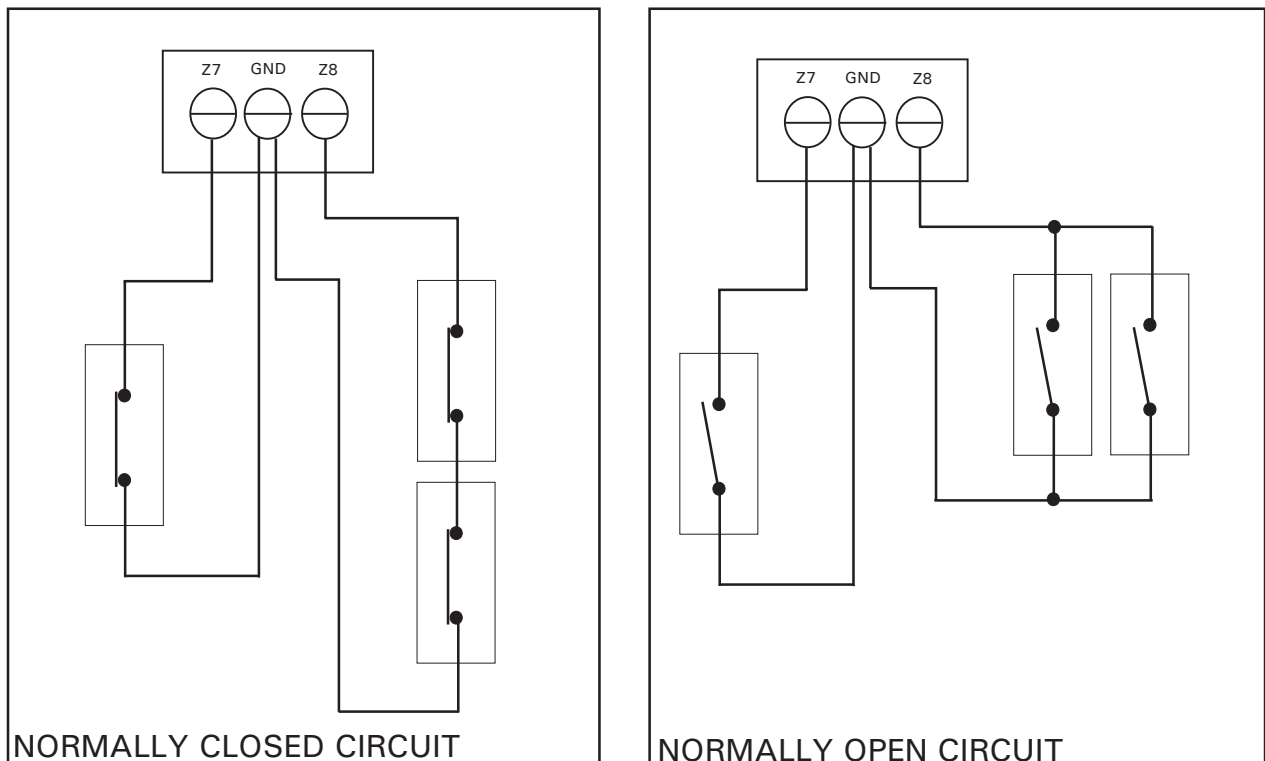

**Figure 9: Examples of Zone Connections with EOLR**

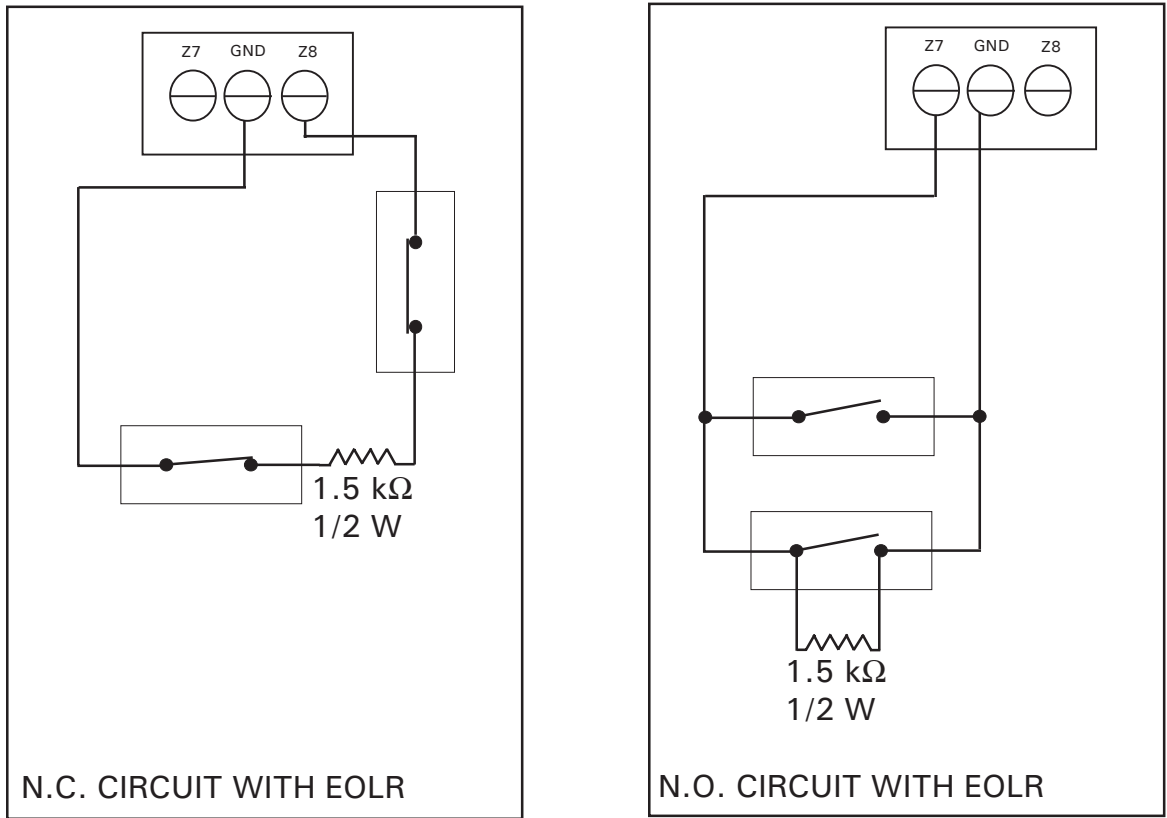

Setting:

**TYPE OF SENSOR**  
**DRY CONTACT** ▼

6. Using the up and down-arrow keys  , scroll the menu until the item displayed is DRY CONTACT and press **Enter** .

**BURGLAR ZONE?**

**YES** ..... (1)  
**NO** ..... (2)

7. Type **2** for an ordinary dry contact input.

**NORM. OPEN** ..... (1)  
**NORM. CLOSED** ..... (2)

8. Type **1** or **2** according to the desired configuration.

W/O RESISTOR . . (1)  
W/ RESISTOR . . . (2)

9. Type **1** to configure the input without an end of line resistor. Type **2** to configure the input with an end of line resistor.

RECOGNITION TIME

RANGE FROM  
(0 .. 59 HR, 0 .. 59 MIN, 0 .. 59 SEC)

RECOGNITION TIME

-- : -- : --

10. To enter the recognition time, enter the hours; press **Enter**. Enter the minutes; press **Enter**. Enter the seconds; press **Enter**. The system returns to the zone number prompt (step 4).

### 3.2.2 Dry Contact Burglar Input

**Definition:** Dry contact inputs can be configured as burglar zones. These zones are armed or disarmed as a group using a password. The connections used are exactly as explained for dry contact inputs (see Section 3.2.1). Two types of configurations are possible depending on when alarms are to be declared. In an instant burglar zone, alarms are declared as soon as they are detected. In a delay burglar zone, alarms are declared only after an **Entry Delay** has elapsed. In this way, the authorized user has time to disarm the burglar zones before an alarm is declared. This delay is common to all delay burglar zones. Similarly, all zones are armed after the **Exit Delay** has elapsed. No recognition time is needed for this type of zone; alarms are validated as soon as detected. The key sequence for arming or disarming is as follows:

• followed by the password sequence **0 8 0 0**



When the system is armed, the system starts beeping and the screen immediately displays a countdown of the exit delay (in minutes and seconds). The keypad is locked at this point: the only key sequence allowed is the disarming sequence. After the exit delay has elapsed, the burglar zones are armed and alarms are immediately declared as they are detected for all burglar zones. The system displays the message "BURGLAR ZONES ARMED" periodically on the screen and the password feature is enabled. The Password key cannot be accessed at this point unless the burglar zones are disarmed.

When an alarm occurs in a burglar zone with an entry delay, the screen displays a countdown of the entry delay. During this time, the piezoelectric loudspeaker beeps (the loudspeaker stops when the key sequence is entered). If no one has disarmed the system after the entry delay has elapsed, an alarm is declared. Disarming will affect all currently active burglar zones. The system displays the message "BURGLAR ZONES DISARMED" on the screen.

A burglar zone cannot be included in a partition. If a zone already belonging to a partition needs to be changed to a burglar zone, it must first be removed from the partition. Otherwise, this is done automatically by the system.

#### Setting:



6. Using the up and down-arrow keys  , scroll the menu until the item displayed is DRY CONTACT and press **Enter**  .



**BURGLAR ZONE?**

**YES . . . . . (1)**  
**NO . . . . . (2)**

7. Type **1** for a burglar zone input.

**INSTANT . . . . . (1)**  
**DELAYED . . . . . (2)**

8. Type **1** if no entry delay is used for this zone. Type **2** to use an entry delay for this zone.

**NORM. OPEN . . . . (1)**  
**NORM. CLOSED . . (2)**

9. Type **1** or **2** according to the configuration desired.

**W/O RESISTOR . . . (1)**  
**W/ RESISTOR . . . . (2)**

10. Type **1** to configure the input without an end of line resistor. Type **2** to configure the input with an end of line resistor. The system returns to the zone number prompt (step 4).

### 3.2.3 Temperature Input

**Definition:** A temperature input responds to changes in temperature readings from a sensor. A high and low set point is entered, defining a range of temperatures between the set points that do not set off an alarm condition.

**Figure 10: Temperature Input**

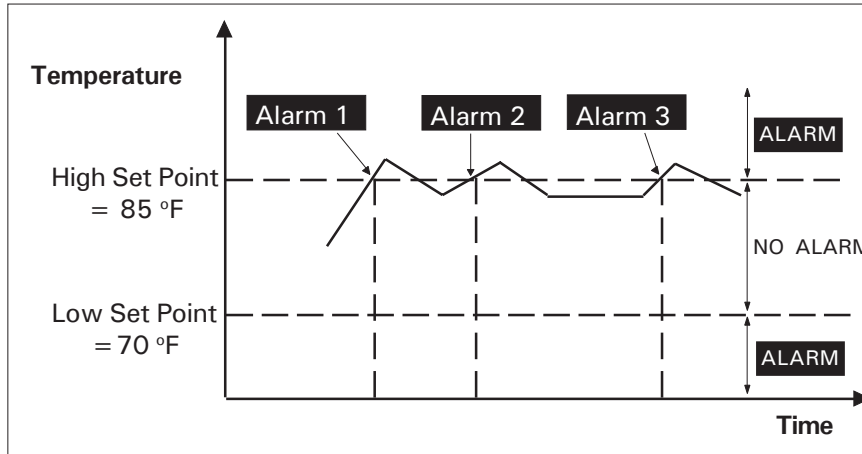

Setting:

**TYPE OF SENSOR**  
**TEMPERATURE** ◆

6. Using the up and down-arrow keys , scroll the menu until the item displayed is TEMPERATURE and press **Enter**.

**RANGE FROM**  
**(-40.0°F .. 149.0 °F)**

**LO SET POINT**  
 \_\_\_\_\_ °F

7. This is the lower value of the normal temperature range. It ranges from -40 °F to 149 °F (-40 °C to 65 °C) with an accuracy of 0.1 °F (0.1 °C). Enter the low set point and press **Enter**. To enter a negative value, use the +/- key, either before or after the digits.

**HI SET POINT**  
 \_\_\_\_\_ °F

8. This is the upper value of the normal temperature range. It ranges from the lower set point to 149 °F (65 °C) with an accuracy of 0.1 °F (0.1 °C). Enter the high set point and press **Enter**. To enter a negative value, use the +/- key, either before or after the digits. The high set point must be greater than the low set point.

**RANGE FROM**  
(X°F .. 149.0 °F)

**CRITICAL TEMP.**  
----- °F

9. This is the absolute temperature limit for room temperatures. It is used in conjunction with the outdoor temperature compensation feature. When the room temperature reaches this point and the outdoor temperature compensation feature is enabled, an alarm is set off, no matter what the outdoor temperature is (see Section 5.3). It ranges from the high set point to 149 °F (65 °C) with an accuracy of 0.1 °F (0.1 °C). Enter the critical temperature and press **Enter**. To enter a negative value, use the  key, either before or after the digits.

**RANGE FROM**  
(0 .. 59 HR, 0 .. 59 MIN, 0 .. 59 SEC)

**RECOGNITION TIME**  
\_\_ : \_\_ : \_\_

10. To enter the recognition time, enter the hours; press **Enter**. Enter the minutes; press **Enter**. Enter the seconds; press **Enter**. The system returns to the zone number prompt (step 4).

### 3.2.4 Pulse Count Input

**Definition:** A pulse count input responds to changes in the pulse sensor, for example from a water flow meter. A high and low set point is entered, defining a normal range of values between the set points for one observation length outside which an alarm condition is reported. The user must also specify an observation length. This is the time period used to calculate the number of pulses.

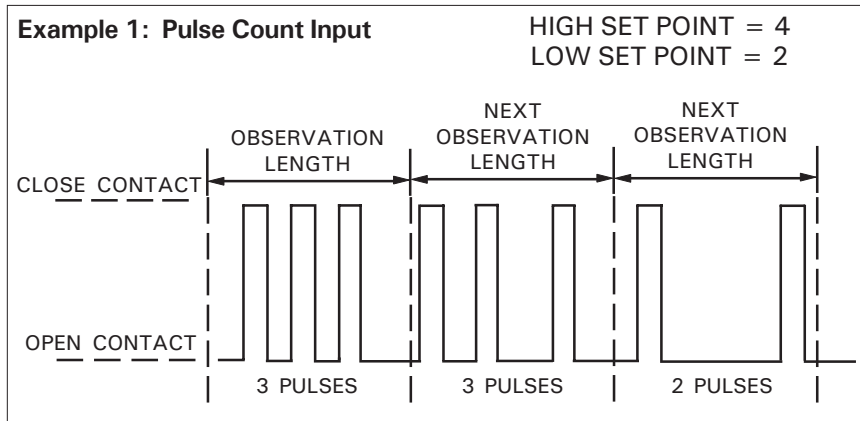

In Example 1 above, the normal range is 2 to 4 pulses within a time period defined by the observation length. No alarm conditions are reported in this example. This type of input is sensitive to the value of the observation length. A difference in the time period used to count the pulses can change the number of alarms reported by the system. Example 2 below uses the same situation as Example 1, except for the observation length which is slightly smaller. As a result of this, an alarm condition is reported. Care must be taken to set the observation length to an appropriate value.

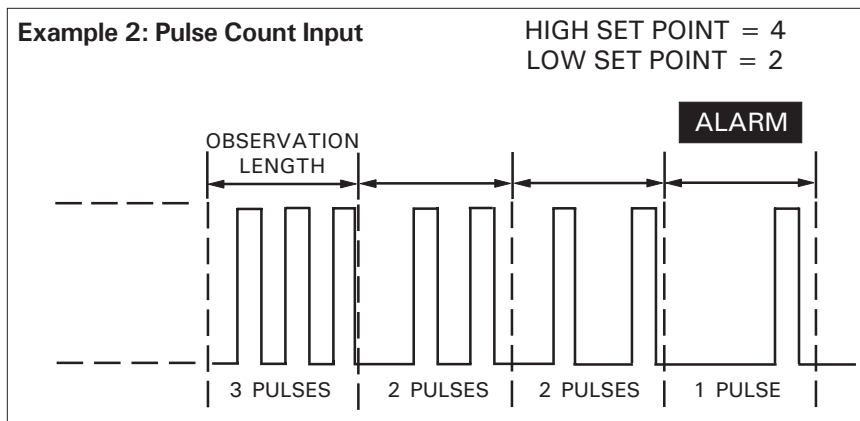

The system has a maximum detection rate of 1 pulse per second. In addition, the system cannot count more than 254 pulses within a given observation length. This must be accounted for when the set points and the observation length are defined. To ensure that the values are within limits, use the maximum rated pulses per unit measured defined for the sensor you are using. For example, a flow meter is rated in pulses per gallon. If you calculate the maximum flow rate in gallons for your observation length and multiply by the pulses per gallon, the resulting value must be less than 254 pulses in order for the system to work properly. The example below sums up the procedure.

Maximum Pulses Allowed

$$\frac{\text{pulses}}{\text{gallon}} \times \frac{\text{max. number of gallons}}{\text{obs. length}} = \frac{\text{maximum pulses}}{\text{obs. length}} < \frac{255 \text{ pulses}}{\text{obs. length}}$$

If the flow meter is rated at: 3 pulses/gallon

Observation length = 1 hour

Number of gallons/hour = 1000/hour

$$\frac{3 \text{ pulses}}{\text{gallon}} \times \frac{1000 \text{ gallons}}{1 \text{ hour}} = \frac{3000 \text{ pulses}}{1 \text{ hour}} > \frac{255 \text{ pulses}}{1 \text{ hour}}$$

The resulting number of pulses exceeds the maximum allowed. The observation length must be reduced. For example, if we try an observation length of 5 minutes, the resulting calculation becomes:

$$\frac{3 \text{ pulses}}{\text{gallon}} \times \frac{83.3 \text{ gallons}}{5 \text{ minutes}} = \frac{250 \text{ pulses}}{5 \text{ minutes}} < \frac{255 \text{ pulses}}{5 \text{ minutes}}$$

Setting:

TYPE OF SENSOR  
PULSE COUNT ▲

6. Using the up and down-arrow keys  , scroll the menu until the item displayed is PULSE COUNT and press **Enter**  .

RANGE FROM  
(0 .. 254)

LO SET POINT  
\_\_\_ PULSES

7. This is the lower value of the normal pulse range. It ranges from 0 to 254. Enter the low set point and press **Enter**.

HI SET POINT  
\_\_\_ PULSES

8. This is the upper value of the normal pulse range. It ranges from the lower set point to 254. The value must be greater than the low set point. Enter the high set point and press **Enter**.

**OBSERVAT. LENGTH**

**RANGE FROM**  
**(0 .. 59 HR; 0 .. 59 MIN; 0 .. 59 SEC)**

**OBSERVAT. LENGTH**  
\_\_ : \_\_ : \_\_

9. To enter the observation length, enter the hours (from 0 to 59 hours); press **Enter**. Enter the minutes (from 0 to 59 minutes); press **Enter**. Enter the seconds (from 0 to 59 seconds); press **Enter**. The system returns to the zone number prompt (step 4).

### 3.2.5 Setting the Reset Time

**Zone Reset Time:** After an alarm has occurred, no new alarm can be detected on the same input until the reset time has elapsed. The zone LED on the front panel continues to flash until the reset time has elapsed and the alarm condition has returned to normal. This parameter is used to configure all alarm inputs except pulse count inputs. All zones use the same reset time. Using a reset time avoids reporting a succession of closely related alarms as separate alarms. For example, in the case of a temperature sensor, small temperature fluctuations around one of the set points can set off a great number of separate alarms. This can be avoided if the reset time is set to an appropriate value. Figure 11 illustrates this situation. An alarm occurs at "A" when the temperature exceeds the high set point (assuming a recognition time equal to zero). This is Alarm 1.

**Figure 11: Illustration of Reset Time**

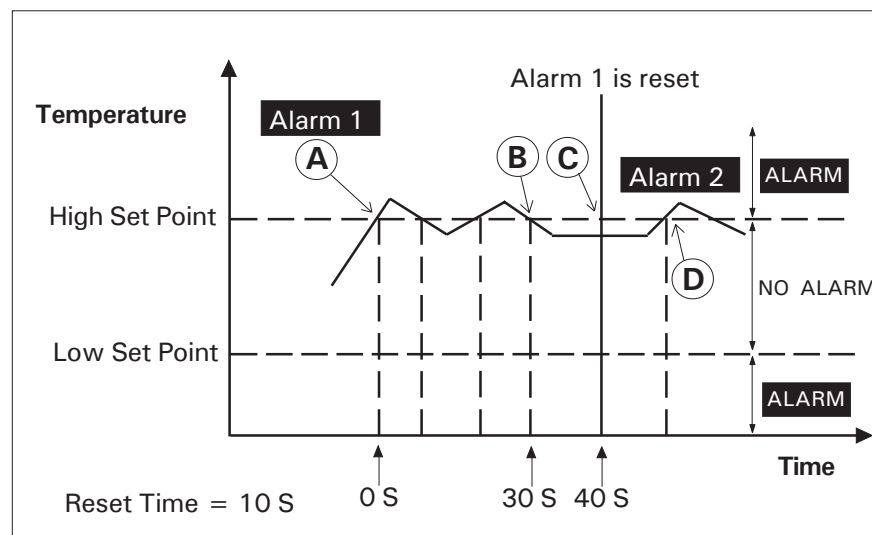

No new alarms can be declared until Alarm 1 is reset. In order for this to happen, the temperature must fall back to a normal state for at least 10 seconds (the reset time). This occurs at "C". At "D", a new alarm can be declared (assuming a zero recognition time once again). The reset time ranges from 0 to 59 hours, 0 to 59 minutes, 0 to 59 seconds. The default is 1 second.

1. Press the **System** key . The current revision number of the software program is displayed. The installer password must then be entered.

**SOFTWARE**  
REV. x.xxx

**ENTER INSTALLER  
PASSWORD: \_ \_ \_ \_**

2. Enter the installer password (0801 by default) and press **Enter** .

**SYSTEM  
PROGRAM AUX'S ▲**

3. Using the up and down-arrow keys  , scroll the menu until the item displayed is PRORGRAM AUX'S and press **Enter** .

**PROGRAM AUX'S  
ZONE RESET TIME ▼**

4. Using the up and down-arrow keys  , scroll the menu until the item displayed is ZONE RESET TIME and press **Enter** .

**ZONE RESET TIME  
XX:YY:ZZ**

**TO MODIFY . . . . (↵)**  
**TO QUIT . . . . . (X)**

5. Press **Enter** to modify the zone reset time.

**ZONE RESET TIME**  
\_ \_ : \_ \_ : \_ \_

6. To enter the reset time, enter the hours; press **Enter**. Enter the minutes; press **Enter**. Enter the seconds; press **Enter**. The system displays the new reset time and returns to the Program Aux's scrolling menu.



### 3.2.6 Disable the Siren

**Definition:** This function allows to disable the siren on specified zones. No siren will be activated when an alarm occurs in these zones. By default, the siren is enabled on all zones.

1. Press the **System** key . The current revision number of the software program is displayed. The installer password must then be entered.



ENTER INSTALLER  
PASSWORD: \_ \_ \_ \_

2. Enter the installer password (0801 by default) and press **Enter** .

SYSTEM  
PROGRAM AUX'S ▲

3. Using the up and down-arrow keys  , scroll the menu until the item displayed is PROGRAM AUX'S and press **Enter** .

PROGRAM AUX'S  
SIREN DISABLED ◆

4. Using the up and down-arrow keys  , scroll the menu until the item displayed is SIREN DISABLED and press **Enter** . Zones without siren are displayed.

NO SIREN ZONE #  
4

SIREN DISABLED  
ADD ZONE ▼

5. Press **Enter**  to ADD a zone on which the siren will be disabled or press the down-arrow key to reactivate the dialer on a zone.

SELECT ZONE  
(1 .. 8): \_

6. Enter the desired zone number then press **Enter** . The system displays zones without sirens and returns to the Program Aux's scrolling menu.

### 3.3 SYSTEM CLOCK

**Definition:** The system has an internal clock that must be set when you first turn the unit on. As a default, the system clock is set to 12:00 PM JANUARY 1, 2001 in AM/PM format. The battery backup used by the Agri-Alert will keep the time and date in case of a power failure. The system displays the message **ADJUST CLOCK** periodically if the date and time have not been set.

#### Setting:

1. Press the **Clock** key . The current date and time are displayed.

TO MODIFY . . . . . (↵)  
TO QUIT . . . . . (X)

2. Type **Enter**  to modify the current settings.

DATE . . . . . (1)  
TIME . . . . . (2)

3. Type **1** to change the date:

ENTER NEW DATE  
\_\_ / \_\_ / \_\_\_\_ M / D / Y

or **2** to change the time:

12 HR (AM & PM) . . (1)  
24 HOUR . . . . . (2)

4. Type **1** for AM/PM time or **2** for 24-hour time.

ENTER NEW TIME  
\_\_ : \_\_ (HR:MIN)

Note that you must press **Enter** after typing each value to step to the next one. For example, to enter the time 9:14, the sequence is: **9 Enter 14 Enter**. If you selected AM/PM time, an additional screen appears:

AM . . . . . (1)  
PM . . . . . (2)

5. Type **1** or **2**. The system updates the Date/Time display.

### 3.4 USER ID MESSAGE

**Definition:** When giving status reports and alarm messages, the system identifies itself with a voice recording provided by the user.

**Setting:**

1. Press the **ID message** key . The current ID message is played over the speaker on the front panel. If no ID message has yet been recorded, the system displays **NONE**.

**ID MESSAGE  
PLAY**

**TO MODIFY . . . . . (↵)  
TO QUIT . . . . . (X)**

2. To modify the current message, press **Enter** . Otherwise, press **Cancel** .

**STATE . . . . . (1)  
MESSAGE . . . . . (2)**

To Activate / Deactivate ID Message:

3. Type **1** to activate or deactivate ID Message.

**ENABLE . . . . . (1)  
DISABLE . . . . . (2)**

4. Type **1** to enable, or **2** to disable the ID Message. The new state is displayed and the system returns to the Date/Time display.

To Modify ID Message:

**STATUS . . . . . (1)  
MESSAGE . . . . . (2)**

3. Type **2** to modify ID Message.

**FOR RECORDING  
PRESS 3 AND HOLD**

4. Press the ID message key  and hold while you speak the message into the microphone on the front panel.

**RECORDING  
07 SEC REMAINING**

5. The screen will count down from a maximum of 7 seconds until the ID message key is released.

**ID MESSAGE  
PLAY**

6. The new message is played over the speaker and the system returns to the Date/Time display.

### 3.5 TEMPERATURE UNITS



**Definition:** Temperatures can be displayed either in Fahrenheit or Celsius units. All temperatures will be displayed according to this definition. The default is Fahrenheit.

**Setting:**

1. Press the °C/°F key . The current value is displayed.

°F

**TO MODIFY . . . . . (↓)  
TO QUIT . . . . . (X)**

2. To modify the current temperature units, press **Enter** . Otherwise, press **Cancel** .

CELSIUS . . . . . (1)  
FAHRENHEIT. . . . .(2)

3. Type **1** for Celsius units, or **2** for Fahrenheit units. The new units are displayed and the system returns to the Date/Time display.



### 3.6 DISPLAY CONTRAST

#### Setting:

1. Press the **Contrast** key . The actual contrast is displayed.

CONTRAST  
80%

80%   
TO SAVE . . . . . (↵)

2. Use the up-arrow key  to increase the contrast. Use the down-arrow key  to decrease the contrast. When you are finished, type **Enter** to save the new setting. The system displays the new setting as a percentage. The final setting is displayed and the system returns to the Date/Time display.

### 3.7 DEFAULT VALUES

**Definition:** The system has default values programmed for all parameters except telephone numbers and user passwords. These values are present when you first turn the unit on. If you have changed some or all of the parameter values and would like to return to the original default values initialized at the factory, follow the procedure outlined below. All the current parameter definitions will be erased and replaced by the default values. Table 1 gives the default values for all system parameters.

1. Press the **System** key . The current revision number of the software program is displayed. The installer password must then be entered.



ENTER INSTALLER  
PASSWORD: \_ \_ \_ \_

2. Enter the installer password (0801 by default) and press **Enter** .

SYSTEM  
PROGRAM AUX'S ▲

3. Using the up and down-arrow keys  , scroll the menu until the item displayed is PRORGRAM AUX'S and press **Enter** .

PROGRAM AUX'S  
SET DEFAULTS ▲

4. Using the up and down-arrow keys  , scroll the menu until the item displayed is SET DEFAULTS and press **Enter** . The system beeps four times and responds with the message: **WARNING: ALL PARAMETERS WILL BE LOST!** This means that all the current parameter definitions will be erased and replaced by default values.

TO SET . . . . . (1)  
TO QUIT . . . . . (2)

5. Enter **1** to set default values or **2** to cancel. The system displays the message **PLEASE WAIT** while initializing the parameter values. When the screen turns back on, the system has been initialized.

**Table 1: Default Values**

PARAMETER		DEFAULT VALUE	RANGE
TEMPERATURE UNITS		°F	°F / °C
CLOCK	TIME	12:00 PM	
	MODE	AM/PM	AM/PM or 24-HOUR TIME
DATE		JAN 1, 2002	
MUTE		DISABLED	ON / OFF
BUSY LINE TRIES		1	0 TO 3
RING UNTIL ANSWER		8	1 TO 20
ANSWERING MACHINE		DISABLED	ON / OFF
MESSAGE REPETITIONS		3	2 TO 15
CALL START DELAY		1 min.	0 TO 59 minutes
TIME BETWEEN CALLS		1 min.	0 TO 59 minutes
# OF CALL REPETITIONS		7	1 TO 7
WAITING TIME FOR DIAL TONE		4 sec.	1 to 15 seconds
PAUSE DELAY KEY		4 sec.	1 to 255 seconds
PULSE/TONE		TONE	PULSE/TONE
DTMF SPEED		80mS	50 to 250 mS
PULSE SPEED	MAKE	39 mS	10 to 100 mS
	BREAK	61 mS	10 to 100 mS
	INTERDIGIT	800 mS	600 to 3000 mS
ON-SITE LISTENING	TIME	30 sec.	0 TO 59 seconds
	STATUS	DISABLED	ENABLED / DISABLED
RESTORE CALLS		DISABLED	ENABLED / DISABLED
SIREN DELAY		5 min.	1 to 20 minutes
ENTRY DELAY		30 sec.	0 to 5 minutes, 0 to 59 seconds
EXIT DELAY		30 sec.	0 to 5 minutes, 0 to 59 seconds
ALARM RECALL TIME		30 min.	from 10 min. to 12 hours, 59 minutes
ALARM MEMORY		EMPTY	
16VAC FAILURE	DELAY	5 min.	0 to 59 minutes, 0 to 59 seconds
	STATUS	ENABLED	ENABLED / DISABLED
OUTDOOR T° COMPEN. (AA-800T ONLY)	OFFSET	5°F (2.8°C)	0°F - 36°F (0 - 20°C)
	STATUS	DISABLED	ENABLED / DISABLED
OUTDOOR PROBE		ZONE 8	1 to 8
DISPLAY CONTRAST		50%	10 TO 100% in steps of 10%

## Default Zone Configurations

PARAMETER	ZONE 2	ZONES 1, 3-7	RANGE
SENSOR TYPE	DRY CONTACT	TEMPERATURE	DRY CONTACT/TEMP./PULSE
OPEN / CLOSED CIRCUIT	N.C.	----	N.O. / N.C.
END OF LINE RESISTOR	WITHOUT EOLR	----	WITH / WITHOUT EOLR
DIALOUT	ENABLED	ENABLED	ENABLED / DISABLED
SIREN	ENABLED	ENABLED	ENABLED / DISABLED
RECOGNITION TIME	1 min.	1 min.	0 to 59 hours, 0 to 59 minutes, 0 to 59 seconds
LOW SET POINT	----	50°F (10°C)	-40°F to 149°F (-40 to 65°C)
HIGH SET POINT	----	85°F (29,4°C)	-40°F to 149°F (-40 to 65°C)
CRITICAL TEMPERATURE	----	95°F (35°C)	-40°F to 149°F (-40 to 65°C)

The default **reset time** on all zones is 1 min. with a range from 0 to 59 hours, 59 minutes, 59 seconds. By default, zone 8 is a temperature zone assigned to the **outdoor probe** for the outdoor temperature compensation feature.



### 3.8 TEST PROCEDURE

The Agri-Alert system has the capability of testing certain functions from the keyboard. To start the test procedure, press the **Test**  key.

#### Outline of Test Procedure:

- 1 — **TEST LEDES:** The front panel LEDs are turned on and turned off, one by one, in sequence from top to bottom and from left to right.
  
- 2 — **TEST LCD:** The LCD display is tested. The LCD backlight is turned off and the display contrast is tested in steps from maximum to minimum contrast. Each character matrix is turned on, two by two, in sequence from left to right. Make sure all the pixels in each square light up.
  
- 3 — **TEST BUZZER:** The internal buzzer is tested.
  
- 4 — **TEST SIREN:** Two short beeps are sent to the siren (if a siren is hooked up).
  
- 5 — **ID SYSTEM:** The Agri-Alert ID message is played over the speaker. Make sure the message is audible.
  
- 6 — **ID MESSAGE:** The user ID message is played over the speaker. Make sure the message is audible. If no message has been recorded, the system displays: NONE.
  
- 7 — **DIALOUT SEQUENCE:** The dialout sequence is launched.

### 3.9 TROUBLE INFORMATION

When the Trouble LED lights up on the front panel, the user can query the system for more information.

1. Press the **Trouble**  key. Information concerning the system trouble is displayed. If no system trouble has been detected, the message "NO TROUBLE" is displayed.

**ZONE #3  
SHORT PROBE**

TO ERASE . . . . . (1)  
TO QUIT . . . . . (2)

2. Type **1** to reset the trouble flag. Note that if the problem has not been corrected, the trouble LED will remain on. Type **2** to exit this function. The system returns to the Date/Time display.

### 3.10 VIEWING SOFTWARE VERSION

1. Press the **System** key . The current revision number of the software program is displayed. The installer password must then be entered.

SOFTWARE  
REV. x.xxx



ENTER INSTALLER  
PASSWORD: \_ \_ \_ \_

2. Enter the installer password (0801 by default) and press **Enter** .

SYSTEM  
PROGRAM AUX'S ▲

3. Using the up and down-arrow keys  , scroll the menu until the item displayed is PROGRAM AUX'S and press **Enter** .

PROGRAM AUX'S  
VERSION SOFTWARE ◆

4. Using the up and down-arrow keys  , scroll the menu until the item displayed is VERSION SOFTWARE and press **Enter** . The version of the software is displayed. The system then returns to PROGRAM AUX'S menu.

SOFTWARE  
REV. x.xxx

### 3.11 STANDBY MODE

**Definition:** When the system is in standby mode, no monitoring of alarm inputs is done. The Standby LED on the display panel and the message SYSTEM ON STANDBY are used to indicate that the system is in Standby mode. **The system can automatically switch to standby mode** when a long power failure has drained the backup battery to a critical level. A pager message (code 8009) and a vocal message (“Low battery; system deactivated”) are sent warning that the system is about to go into standby mode. When normal voltage is restored to the battery, the system returns to its normal mode of operations. If the system is already in standby mode when the problem is detected, no messages are sent.

#### Setting:

1. Press the **On/Off** key . The system prompts for a password.

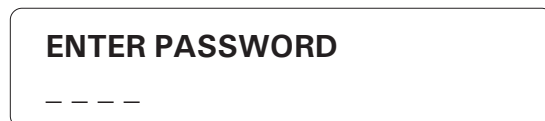

ENTER PASSWORD  
- - - -

2. Type a four-digit password and press **Enter** . If an incorrect password is entered, the system responds with the message “**WRONG PASSWORD**” and returns to the Date/Time display. Otherwise, the system displays the current system status: **ON** — the system is running normally; **OFF** — the system is in standby mode.





OK



STATUS: ON



TO MODIFY..... (↵)  
TO QUIT..... (X)

3. Press **Enter**  to modify or **Cancel**  to quit. The system displays the new status and returns to the Date/Time display.

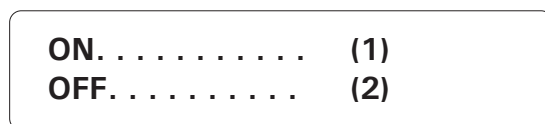

ON..... (1)  
OFF..... (2)



4. Type **1** to enable, or **2** to disable Standby mode. The new setting is displayed, and the system returns to the Date/Time display.

## CHAPTER FOUR: COMMUNICATION PARAMETERS

### 4.1 DIALING INFORMATION

**Definition:** These parameters are used to establish communications over the telephone network when the dialout sequence is used.

**Setting:**

1. Press the **System** key . The current revision number of the software program is displayed. The installer password must then be entered. Enter the installer password (0801 by default) and press **Enter** .



SOFTWARE  
REV. x.xxx

ENTER INSTALLER  
PASSWORD: \_ \_ \_ \_ \_

2. Using the up and down-arrow keys  , scroll the menu until the item displayed is PROGRAM DIALING and press **Enter** .

SYSTEM  
PROGRAM ZONES ▼

SYSTEM  
PROGRAM DIALING ▲▼

3. To modify a parameter, scroll the menu using the up and down arrow keys   until you reach the parameter you want to modify and press **Enter**.

PROGRAM DIALING  
CALL START DLY ▼

### 4.1.1 Dialing Mode and Speed

**Definition:** The user can choose between pulse and tone dialing. Both methods have parameters associated with dialing speed. When changing these parameters, make sure the new values are compatible with your local telephone network. If this is not the case, the system may not be able to dial out.

1. DTMF Speed (Dual Tone Multiple Frequency Speed): This is the dialing speed used on tone dialing lines. Tone dialing is available only when the central telephone office is equipped to process the tones. Some rural areas, for example, are not equipped for tone dialing. The speed corresponds to the length of the tone as well as the delay between digits (or interdigit time). The value ranges from 50 to 250 milliseconds. The default is 80 mS.

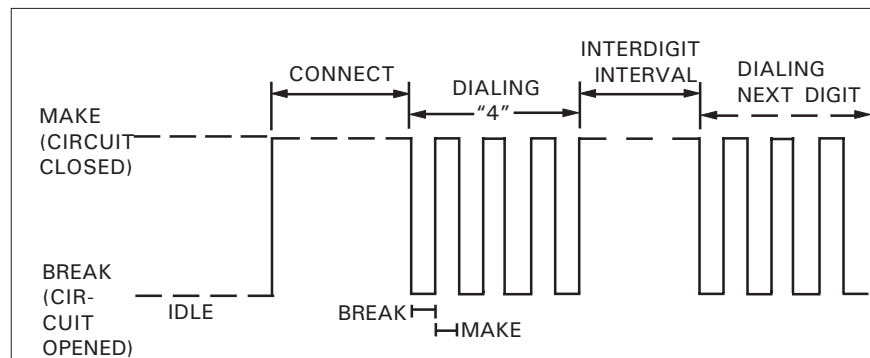

2. Pulse Speed: This is the dialing speed used on pulse dialing lines. When tone dialing is not available, pulse dialing is used. Pulse dialing uses a timed interval of circuit opening and closing called a dial pulse period. Each digit is translated as a series of pulses. Each digit is separated by an interdigit interval (see Figure 23). The pulse period is the sum of the make (circuit closed) and the break (circuit opened). The make ranges from 10 to 100 msec (default 39 mS); the break ranges from 10 to 100 msec (default 61 mS); the interdigit ranges from 0.6 to 3 seconds (default is 0.8 seconds).

Figure 12: Pulse Timing Parameters



#### 4.1.1.1 Dialing Mode

4. Follow the procedure above for modifying the dialing parameters (Section 4.1).

When you reach the scrolling menu, use the arrow keys   to select Dialing

Mode then press **Enter**  .





MODE . . . . . (1)  
SPEED . . . . . (2)

5. Type **1** to modify dialing mode. The current dialing mode is displayed.

DIALING MODE  
TONE

TO MODIFY . . . . . (↵)  
TO QUIT . . . . . (X)



6. Press **Enter**  to modify the value or **Cancel**  to quit.

TONE . . . . . (1)  
PULSE . . . . . (2)

7. Type **1** for tone dialing, or **2** for pulse dialing. The new setting is displayed and the system returns to the Program Dialing scrolling menu.

**4.1.1.2 Tone Dialing Speed**

4. Follow the procedure above for modifying the dialing parameters (Section 4.1).

When you reach the scrolling menu, use the arrow keys   to select Dialing Mode then **Enter**  .

PROGRAM DIALING  
DIALING MODE ◆

MODE . . . . . (1)  
SPEED . . . . . (2)



5. Type **2** to modify dialing speed.

TONE . . . . . (1)  
PULSE . . . . . (2)

6. Type **1** to modify tone dialing speed. The current parameter setting is displayed.

DTMF SPEED  
80 MSEC

TO MODIFY . . . . . (↓)  
TO QUIT . . . . . (X)



7. Press **Enter**  to modify the value or **Cancel**  to quit.

RANGE FROM  
(50 .. 250 MSEC)

DTMF SPEED  
\_\_\_ MSEC

8. Enter the value desired and press **Enter**. The new setting is displayed and the system returns to the Tone/Speed display.

#### 4.1.1.3 Pulse Dialing Speed



4. Follow the procedure above for modifying the dialing parameters (Section 4.1). When you reach the scrolling menu, use the arrow keys   to select Dialing Mode then press **Enter**  .

PROGRAM DIALING  
DIALING MODE ◆

MODE . . . . . (1)  
SPEED . . . . . (2)

5. Type **2** to modify dialing speed.

TONE . . . . . (1)  
PULSE . . . . . (2)

6. Type **2** to modify pulse dialing speed. A scrolling menu appears. Use the arrow keys   to select the item to modify: Make, Break, or Interdigit Interval.

#### Modifying the Make Value:



7. In the scrolling menu for Pulse Speed, use the arrow keys   to select Make

PULSE  
MAKE ▼

8. Press the **Enter**  key at **Make**; the current parameter setting is displayed.

**PULSE SPEED**  
**MAKE: 63MSEC**

**TO MODIFY . . . . . (↵)**  
**TO QUIT . . . . . (X)**

9. Press **Enter**  to modify the value or **Cancel**  to quit.

**RANGE FROM**  
**(10 .. 100 MSEC)**

**MAKE**  
**\_\_\_ MSEC**

10. Enter the value desired and press **Enter**. The new setting is displayed and the system returns to the Pulse Speed scrolling menu.

Modifying the Break Value:



7. In the scrolling menu for Pulse Speed, use the arrow keys   to select **Break**

**PULSE**                        
**BREAK**                     

8. Press the **Enter**  key at **Break**; the current parameter setting is displayed.

**PULSE SPEED**  
**BREAK: 50 MSEC**

**TO MODIFY . . . . . (↵)**  
**TO QUIT . . . . . (X)**

9. Press **Enter**  to modify the value or **Cancel**  to quit.



**RANGE FROM**  
**(10 .. 100 MSEC)**



BREAK  
\_\_\_ MSEC

10. Enter the value desired and press **Enter**. The new setting is displayed and the system returns to Pulse Speed scrolling menu.

Modifying the Interdigit Interval:



7. In the scrolling menu for Pulse Speed, use the arrow keys   to select Interdigit

PULSE  
INTERDIGIT ▲

8. Press the **Enter**  key at Interdigit; the current parameter setting is displayed.

PULSE SPEED  
INTERDIGIT: 0.8 SEC

TO MODIFY. . . . . (↵)  
TO QUIT. . . . . (X)

9. Press **Enter**  to modify the value or **Cancel**  to quit.

RANGE FROM  
(0.6 .. 3 SEC)

INTERDIGIT  
\_\_\_ SEC



10. Enter the value desired and press **Enter**. The new setting is displayed and the system returns to Pulse Speed scrolling menu.

### 4.1.2 Line Seizure

**Definition:** This parameter is used to activate or deactivate line seizure if your system has been wired for line seizure (see section 1.3.4). If this feature is not activated, line seizure will not function even if the proper wiring connections have been made.

**Setting:**



4. Follow the procedure above for modifying the dialing parameters (Section 4.1).

When you reach the scrolling menu, use the arrow keys   to select Line Seizure.



5. Press **Enter**  . The current parameter setting is displayed.



6. Press **Enter**  to modify the value or **Cancel**  to quit.

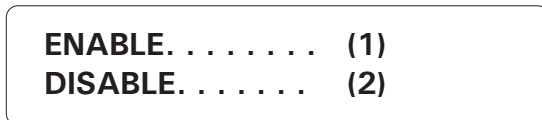



7. Type **1** to enable line seizure, or **2** to disable line seizure. The new setting is displayed and the system returns to Program Dialing scrolling menu.

### 4.1.3 Call Repetitions

**Definition:** When an alarm is validated, the system starts calling the phone numbers stored in memory to deliver the alarm message. The Call Repetitions value determines the number of times this procedure is accomplished within one alarm dialout sequence. The value ranges from 1 to 7 times. The default is 7.

#### Setting:



4. Follow the procedure above for modifying the dialing parameters (Section 4.1). When you reach the scrolling menu, use the arrow keys   to select #of Call Repetitions.

PROGRAM DIALING  
# OF CALL REPS. 

5. Press **Enter** . The current parameter setting is displayed.

# OF CALL REPS.  
6 CALLS

TO MODIFY . . . . . (↵)  
TO QUIT . . . . . (X)

6. Press **Enter**  to modify the value or **Cancel**  to quit.

RANGE FROM  
(1 .. 7 CALLS)



# OF CALL REPS.  
\_ CALLS

7. Enter the value desired and press **Enter**. The new setting is displayed and the system returns to the Program Dialing scrolling menu.

#### 4.1.4 Message Repetitions

**Definition:** The number of times a voice message is delivered by the system when an alarm condition is reported. This applies to the messages given over the phone and on the unit speaker. The value ranges from 2 to 15 times. The default is 3.

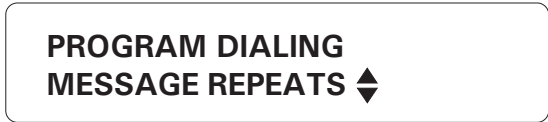

**Setting:**

4. Follow the procedure above for modifying the dialing parameters (Section 4.1). When you reach the scrolling menu, use the arrow keys   to select Message Repeats.



5. Press **Enter**  at Message Repetitions. The current parameter setting is displayed.



6. Press **Enter**  to modify the value or **Cancel**  to quit.



7. Enter the value desired and press **Enter**. The new setting is displayed and the system returns to the Program Dialing scrolling menu.

### 4.1.5 Busy Line Tries



**Definition:** The number of times a phone number is called when the line is busy. This parameter applies equally to all the phone numbers in the dialout sequence. The value ranges from 0 to 3 tries. The default is 1 try. When a line is busy and Busy Line Tries is greater than zero, the busy number is placed at the end of the dialout sequence.

Once all the other numbers have been dialed, the system returns to the busy numbers and tries again, etc. If the number is reached before all the tries defined in Busy Line Tries have been done, it is not redialed.

**Note:** If you have not configured the phone hookup to provide line seizure capability and someone is using the phone when the dialout sequence is launched, the system counts this as a try, as if all the phone numbers in the dialout sequence were busy. If the Busy Line Tries parameter is set to zero, no other tries will be made in this case and the alarms that set off the dialout sequence will automatically be acknowledged.

#### Setting:

4. Follow the procedure above for modifying the dialing parameters (Section 4.1).



When you reach the scrolling menu, use the arrow keys   to select Busy Line Tries.

```
PROGRAM DIALING
BUSY TRIES      ▲
```

5. Press **Enter**  . The current parameter setting is displayed.

```
BUSY TRIES
1 TIME
```

```
TO MODIFY..... (↵)
TO QUIT..... (X)
```

6. Press **Enter**  to modify the value or **Cancel**  to quit.

```
RANGE FROM
(0 .. 3 TIMES)
```

```
BUSY TRIES
_  TIMES
```

7. Enter the value desired and press **Enter**. The new setting is displayed and the system returns to the Program Dialing scrolling menu.

### 4.1.6 Tone Delay

**Waiting Time for Dial Tone:** This is the time the system waits after hooking up to a line before dialing a number. This ensures that the line is ready before dialing (see Figure 13 below). The system can be set to wait from 1 to 15 seconds after hookup. The default is 4 seconds.

**Figure 13: Waiting Time**

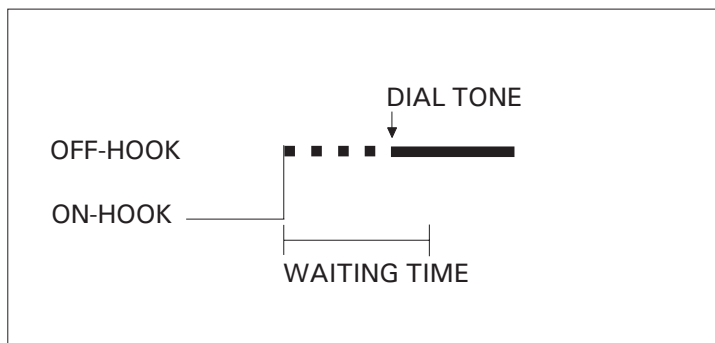

#### Setting:



4. Follow the procedure above for modifying the dialing parameters (Section 4.1).

When you reach the scrolling menu, use the arrow keys   to select Tone Delay.

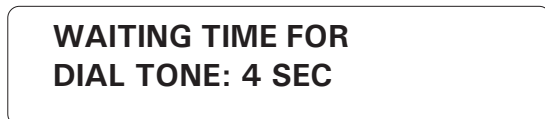

5. Press **Enter**  at Tone Delay. The system prompts for the waiting time.



6. Press **Enter**  to modify the value or **Cancel**  to quit.

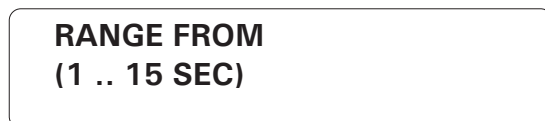



7. Enter the value desired and press **Enter**. The new parameter setting is displayed and the system returns to Program Dialing scrolling menu.

#### 4.1.7 Pause Delay Key

**Definition:** This parameter is associated with the **Pause** key . This key is used to introduce a pause in a telephone number when dialing. The Pause Delay is the length of the pause. For example, if you need to exit a local phone network before reaching an outside line, you can use the **Pause** key after entering the access code (usually '9' –see Section 4.2). The range is from 1 to 255 seconds. The default is 4 seconds.

#### Setting:



4. Follow the procedure above for modifying the dialing parameters (Section 4.1). When you reach the scrolling menu, use the arrow keys   to select Pause Delay.

PROGRAM DIALING  
PAUSE DELAY KEY ▲

5. Press **Enter** . The current parameter setting is displayed.

PAUSE DELAY KEY  
4 SEC

TO MODIFY . . . . . (↵)  
TO QUIT . . . . . (X)

6. Press **Enter**  to modify the value or **Cancel**  to quit.

RANGE FROM  
(1 .. 255 SEC)

PAUSE DELAY KEY  
\_ \_ \_ SEC



7. Enter the value desired and press **Enter**. The new setting is displayed and the system returns to the Program Dialing scrolling menu.

### 4.1.8 Call Start Delay

**Definition:** The time between the validation of an alarm and the beginning of the dialout sequence. A zero value means the dialout sequence begins immediately after an alarm validation. When an alarm is validated, a message is delivered on-site through the speaker on the front panel and the siren is sounded if it is enabled for the zone in alarm. Call Start Delay allows someone on-site to acknowledge an alarm before the dialout sequence is launched. Note that if MUTE is enabled, no message is delivered on-site before dialout. The value ranges from 0 to 59 minutes. The default is 1 minute.

#### Setting:



4. Follow the procedure above for modifying the dialing parameters (Section 4.1).

When you reach the scrolling menu, use the arrow keys   to select Call Start Delay.

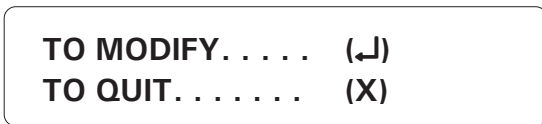

5. Press **Enter** . The current parameter setting is displayed.



6. Press **Enter**  to modify the value or **Cancel**  to quit.





7. Enter the value desired and press **Enter**. The new setting is displayed and the system returns to the Program Dialing scrolling menu.





#### 4.1.9 Time Between Calls

**Definition:** The delay after a phone number has been called, before proceeding with the next number in the dialout sequence. If someone who has received a voice message is unable to acknowledge the alarm at the time of the call, this delay will allow time to stop the dialout sequence between calls. For example, when the alarm message is received on a pager or beeper, the user may need more time to phone back and acknowledge. If the system is continuously dialing out, no calls can be made to the system to acknowledge an alarm. A time delay between calls that is greater than zero makes this possible. The value ranges from 0 to 59 minutes. The default is 1 minute.

4. Follow the procedure above for modifying the dialing parameters (Section 4.1).



When you reach the scrolling menu, use the arrow keys   to select Between Call Time.

PROGRAM DIALING  
BETWEEN CALL TM 

5. Press **Enter** . The current parameter setting is displayed.

BETWEEN CALL TIME  
1 MIN

TO MODIFY..... (↵)  
TO QUIT..... (X)

6. Press **Enter**  to modify the value or **Cancel**  to quit.

RANGE FROM  
(0 .. 59 MIN)

BETWEEN CALL TM  
\_\_ MIN



7. Enter the value desired and press **Enter**. The new setting is displayed and the system returns to the Program Dialing scrolling menu.

#### 4.1.10 Alarm Recall Time

**Definition:** This parameter is used to relaunch the dialout sequence when an alarm has been acknowledged but has not been reset. Alarm recall time is the length of time between the time the alarm is acknowledged and the time the dialout sequence is relaunched (as long as the zone has not returned to its normal state for the duration of reset time). If the alarm is reset before the alarm recall time has elapsed, the planned dialout sequence is cancelled. This parameter ranges from 0 to 12 hours, 59 minutes. The default value is 30 minutes.

#### Setting:

4. Follow the procedure above for modifying the dialing parameters (Section 4.1).



When you reach the scrolling menu, use the arrow keys   to select Alarm Recall Time.

**PROGRAM DIALING**  
**ALARM RECALL TM** 

5. Press **Enter** . The current parameter setting is displayed.

**ALARM RECALL TM**  
**00 HR, 30 MIN**

**TO MODIFY..... (↵)**  
**TO QUIT..... (X)**

6. Press **Enter**  to modify the value or **Cancel**  to quit.



**RANGE FROM**  
**(0 .. 12HR, 59 .. MIN)**

**ALARM RECALL TM**  
**\_\_ : \_\_ (HR:MIN)**

7. Enter the value desired and press **Enter**. The new setting is displayed and the system returns to the Program Dialing scrolling menu.

#### 4.1.11 Restore Calls

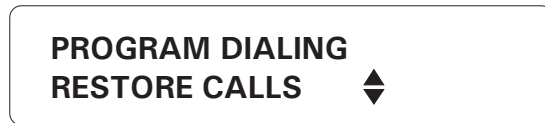

**Definition:** This feature launches the dialout sequence when a zone in alarm returns to its normal state to advise of the change. It can be enabled or disabled and the default setting is DISABLED.

4. Follow the procedure above for modifying the dialing parameters (Section 4.1). When you reach the scrolling menu, use the arrow keys   to select Restore Calls.



5. Press **Enter** . The current parameter setting is displayed.



6. Press **Enter**  to modify the value or **Cancel**  to quit.

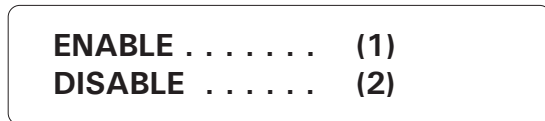



7. Type **1** to enable restore calls, or **2** to disable restore calls. The new setting is displayed and the system returns to Program Dialing scrolling menu.

#### 4.1.12 Disable the Dialer

**Definition:** This function allows to disable the dialing sequence in specified zones. The dialout sequence will not be launched when an alarm occurs in a zone that has a disabled dialer. By default, the dialer is enabled on all zones.

4. Follow the procedure above for modifying the dialing parameters (Section 4.1).

When you reach the scrolling menu, use the arrow keys   to select Dialer Disabled.

**PROGRAM DIALING  
DIALER DISABLED ▲**

5. Press **Enter** . The zones without dialer are displayed.

**NO DIALER ZONE #  
4**

6. Press **Enter**  to ADD a zone on which the dialer will be disabled. Press the down-arrow key to remove a zone from the dialer-disabled list.

**DIALER DISABLED  
ADD ZONE ▼**

7. Press **Enter**  to ADD a zone on which the dialer will be disabled. Press the down-arrow key to remove a zone from the dialer-disabled list.



**SELECT ZONE  
(1 . . 8) : \_**

8. Select the zone on which the dialer must be disabled then press **Enter** . The new setting is displayed and the system returns to Dialer Disabled menu.

## 4.2 PHONE NUMBERS

**Definition:** Phone numbers are used to report alarm conditions. Various methods are available: voice messages, paging and beeper calls. Each number can contain up to 20 digits. A maximum of 8 phone numbers can be stored by the system. The order of the numbers stored in memory defines the dialout sequence used when an alarm is validated, i.e. the first number stored is the first number called in an alarm.

### Setting:

1. Press the **Phone numbers** key . The numbers currently stored in memory are displayed along with their parameter definitions. To stop the display and enter programming mode, press the **Cancel** key .



TO MODIFY . . . . . (↵)  
TO QUIT . . . . . (X)

2. Press **Enter**  to modify.



SELECT PHONE  
NUMBER (1 .. 8): \_

3. Type the number of the phone number to modify and press **Enter**. The current value for this phone number is displayed.

ENTER PHONE #n

4. Type the phone number. Up to 20 digits can be entered. If you press the Enter key without entering any digits, the current phone number is erased from memory and the message PHONE NUMBER DELETED is displayed. Special characters are available for use with tone dialing: use the **Asterisk (\*)**  or **Pound (#)**  keys to enter these characters in a phone number. Each one of these characters counts as one digit in the number. Press the **Pause**  key to enter a pause in the dialing. This is useful when an access code is needed to reach an outside telephone line. For example if you dial "9" to access the telephone lines and wait 4 seconds before dialing the number, you can use the Pause key feature. Set the Pause Delay parameter to the smallest value needed for dialing pauses, for example 1 second. In the phone number definition,

press the pause  key as many times as needed for the length of the pause. For example, **9 - Pause - Pause - Pause - 1234567** will wait three seconds before dialing the seven-digit number (note that the Pause key is displayed as P on the screen).

5. Once all the digits have been entered, press **Enter**. The new phone number is displayed. The system then prompts for the type of system associated with the number. The possible types are presented in a scrolling menu. Use the arrow keys   to select the type and press **Enter**.

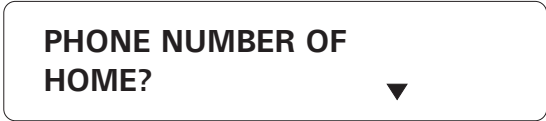

**Home:** When this type of number is called, the system delivers a voice message describing the alarm condition to a home telephone. Press **Enter** to select this option. The system prompts for another phone number. If you are finished, press **Cancel**.

**Cellular:** When this type of number is called, the system delivers a voice message describing the alarm condition to a cellular telephone. Press **Enter** to select this option. The system prompts for another phone number. If you are finished, press **Cancel**.

**Beeper:** This type of number is used with beeper systems. When the number is dialed, the beeper unit simply beeps. Press **Enter** to select this option. The system prompts for another phone number. If you are finished, press **Cancel**.

**Pager:** This type of number is used to access a numeric pager system. When a pager device is paged, a code number is displayed on the pager screen. The Agri-Alert uses this number to transmit information to the user. The code is in the form of a telephone number and contains the following information:

**1SS - AAAA**

**AAAA:** is the four-digit code describing the type of alarm.

**SS:** is the two-digit code of the site where the alarm occurred.

**1:** is a place-holder

SS is the site where the Agri-Alert is installed. AAAA is an alarm code generated by the Agri-Alert. The site number is defined by the user. For example, if two Agri-Alerts are installed on separate sites, the user can identify each site with a unique code number. In the example below, alarm code 3000 is used as a test code.

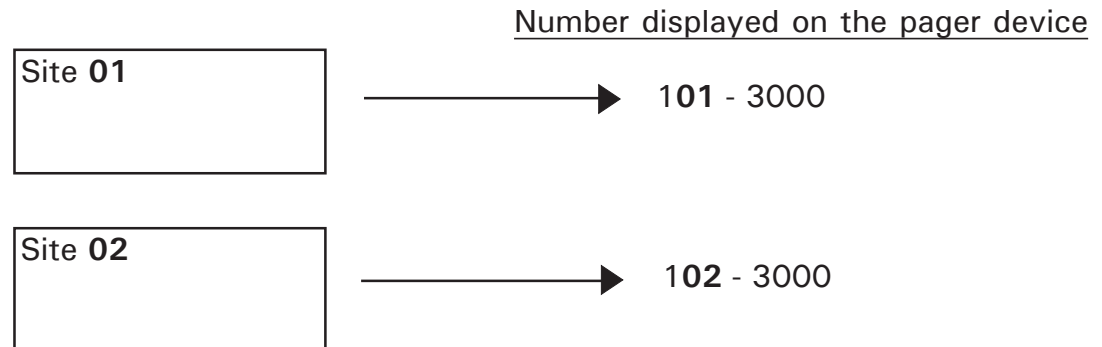

Table 2 below defines the codes used. **RESTORE ZONE** means the zone returns to its normal state.

**Table 2: Pager Codes Used by the Agri-Alert System**

PAGER CODE		MEANING
1001, 1002, ... , 1008		ALARM ZONE 1, 2, ... , 8
2001, 2002, ... , 2008		RESTORE ZONE 1, 2, ... , 8
3000		TEST
PROBLEM ENCOUNTERED	8001	LOW BATTERY
	8002	16VAC FAILURE
	8005	SIREN DEFECT
	8006	12VDC OUTPUT DEFECT
	8008	SYSTEM TROUBLE
	8009	SYSTEM AUTO STANDBY
PROBLEM RESTORED	9001	BATTERY O.K.
	9002	16VAC O.K.
	9005	SIREN O.K.
	9006	12VDC O.K.

Figure 14 below shows the sequence of events. The Agri-Alert first dials the number of the pager device. When the pager system responds, the Agri-Alert waits for the voice message from the pager system to finish. In the diagram, this is called the message delay. The diagram shows an additional delay used to ensure that the pager system is ready to receive the code number from the Agri-Alert system. This is up to the system (usually 3 seconds). Following this, the Agri-Alert dials the seven digit code number or numbers to be displayed on the pager device. When configuring a number as a pager number, the user enters the value: **Message Delay** when the system prompts for the Delay for Pager.

**Figure 14: Calling a Pager Number**

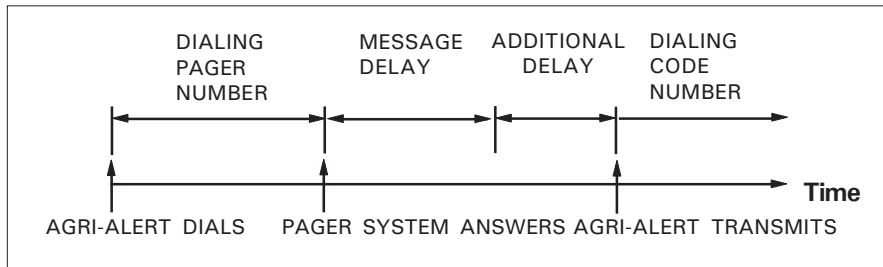

6. To configure a phone number as a pager number, use the arrow keys to scroll to the Pager item in the menu:

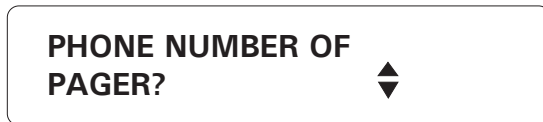

7. Press **Enter** to select this option.

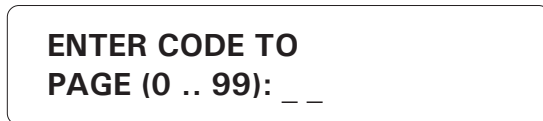

8. Enter the two digit code used to identify the site and press **Enter**.



9. Enter the total delay (Message Delay) used to wait for the end of the pager message and press **Enter**. The system prompts for another phone number. If you are finished, press **Cancel**.



### 4.3 ON SITE LISTENING



**Definition:** This feature allows the user to listen to on-site sounds during a status report or an alarm report. The integrated microphone on the control panel is used for this purpose. The user can enable or disable on-site listening and adjust the listening time. The default setting is DISABLED with a listening time of 30 seconds.

**Setting:**

1. Press the **On-site Listening** key . The status (Enabled/Disabled) is displayed, followed by the current listening time.

**STATUS: ENABLE**  
**DELAY: 10 SEC.**

**TO MODIFY. . . . . (↓)**  
**TO QUIT. . . . . (X)**

2. Press **Enter**  to modify or **Cancel**  to quit.

**STATUS . . . . . (1)**  
**DELAY . . . . . (2)**

3. Type **1** to modify the current value to the opposite state. The system displays the new setting and returns to the Date/Time display. Type **2** to modify the delay.

**RANGE FROM**  
**(0 .. 59 SEC)**

**ENTER NEW DELAY**  
**\_\_ SEC**

4. Enter the new delay and press **Enter**. The system displays the new delay setting and returns to the Date/Time display.

#### 4.4 RINGS / ANSWERING MACHINE

**Definition:** The user can define the number of rings before an incoming call is answered, for example for a status report. The values range from 1 to 20 rings. The system can also be configured to connect a telephone answering device on the same phone line. When this feature is enabled, the Agri-Alert system answers incoming calls only if a special ring sequence is followed. Otherwise, the telephone answering device takes the call after a preset number of rings. The special ring sequence used to connect to the Agri-Alert system is as follows:

- dial the Agri-Alert phone number and hang-up after one ring
- redial the number after 30 seconds have elapsed
- after the first ring, the Agri-Alert system will answer the call



If the answering machine is set to answer after one ring, it must be set to more than one ring for this sequence to work. If an answering machine is not used, any calls made to the Agri-Alert system are answered after the number of rings defined. By default, the number of rings is set to 8 and the answering machine feature is disabled.

#### Setting:

1. Press the **Ring** key . The current parameter setting is displayed.

**8 RINGS**

TO MODIFY..... (↵)  
TO QUIT..... (X)

2. Press **Enter**  to modify the value or **Cancel**  to quit.

**DO YOU HAVE ANSWERING MACHINE?**

YES ..... (1)  
NO ..... (2)

#### To Enable / Disable Answering Machine:

3. Type **1** to use an answering machine with the Agri-Alert system. The system returns to the Date/Time display.

To Set Number of Rings:

3. Type **2** to disable the answering machine feature and set the number of rings before the Agri-Alert system answers a call.

**RANGE FROM**  
(1 .. 20)

**ENTER NEW NUMBER**  
**OF RINGS:** \_ \_

4. Type the new number of rings and press **Enter**. The system displays the new value and returns to the Date/Time display.

#### 4.5 SYSTEM'S VOICE MUTE

**Definition:** When an alarm condition is validated, an alarm message is immediately delivered through the unit speaker. You can turn the speaker on or off. By default, the mute function is disabled and the speaker is turned on.

**Setting:**

1. Press the **System** key . The current revision number of the software program is displayed. The installer password must then be entered.

**SOFTWARE**  
REV. x.xxx

**ENTER INSTALLER**  
**PASSWORD:** \_ \_ \_ \_

2. Enter the installer password (0801 by default) and press **Enter** .

**SYSTEM**  
**PROGRAM AUX'S** ▲

3. Using the up and down-arrow keys  , scroll the menu until the item displayed is PROGRAM AUX'S and press **Enter** .

**PROGRAM AUX'S**  
**SYST.VOICE MUTE** ◆

4. Using the up and down-arrow keys   , scroll the menu until the item displayed is SYSTEM'S VOICE MUTE and press **Enter**  .

**SYST.VOICE MUTE**  
**STATUS: DISABLE**

**TO MODIFY . . . . . (↵)**  
**TO QUIT . . . . . (X)**

5. The status (Enabled/Disabled) is displayed. Press **Enter** to modify the status.

**ENABLE . . . . . (1)**  
**DISABLE . . . . . (2)**

6. Type **1** to enable restore calls, or **2** to disable the speaker. The new setting is displayed and the system returns to Program Aux's scrolling menu.

## CHAPTER FIVE: ALARM PARAMETERS

### 5.1 ALARM VALIDATION: SUMMARY OF EVENTS

ACTION	RESPONSE	PARAMETERS
1. AN ALARM IS DETECTED.	The system measures the time elapsed since the detection of the alarm until <i>Recognition Time</i> is reached.	Recognition Time
2. AN ALARM IS VALIDATED.	When <i>Recognition Time</i> has elapsed, A voice message is delivered on-site to report the alarm (unless MUTE is enabled). The system measures the time elapsed since validation until <i>Call Start Delay</i> is reached. If a siren is connected to the siren output, it is activated.	Mute Call Start Delay
3. DIALOUT BEGINS.	When <i>Call Start Delay</i> has elapsed, each phone number in the dialout sequence is called; each call is separated by <i>Time between calls delay</i> . If this is an ordinary phone or cellular number, a voice message is delivered. The number of times the message is delivered depends on the value of <i>Message Repetitions</i> . If the mute function is disabled, this message is also delivered on-site. For a pager number, an alarm code is sent to the pager system. For a beeper number, the beeper unit is called. Busy numbers are placed at the end of the dialout sequence and redialed according to <i>Busy Tries</i> . Dialout continues until either the alarm is acknowledged, or the dialout sequence has been executed according to the value of <i># of Call Repetitions</i> .	Time Between Calls Message Repetitions Busy Tries # of Call Repetitions Dial Tone Detection Pause Delay Key Dial Speed
4. ALARM IS ACKNOWLEDGED.	Dialout sequence is stopped. If a siren is connected to the siren output, it is stopped. If the alarm was acknowledged over the phone and if <i>On Site Listening</i> is enabled, the user can listen to on-site sounds according to the delay defined for on-site listening.	On Site Listening

## 5.2 SYSTEM ALARMS

**Definition:** The Agri-Alert system detects certain internal alarm conditions that behave in the same way as a zone alarm, i.e. the siren is activated, the dialout sequence is launched, etc. These alarms have a fixed recognition time of 2 minutes and a reset time of 45 minutes if no one is present or 2 minutes if someone is present ( i.e. the display backlight is turned on – the reset time for low battery and system trouble alarms is always 45 minutes). The table below describes these alarms:

**Table 3: System Alarms**

ALARM TYPE	MEANING
LOW BATTERY	BATTERY VOLTAGE IS LESS THAN 10.5 V FOR MORE THAN 2 MIN.
SIREN DEFECT	SIREN FUSE F8 BLOWN / SIREN WIRE TROUBLE / SIREN MALFUNCTION
12VDC OUTPUT DEFECT (on 800T models only)	FUSE F4 BLOWN
SYSTEM TROUBLE	WIRING TROUBLE ON ZONE INPUTS OR SYSTEM MALFUNCTION

### 5.2.1 Backup Battery Voltage Readout

See Appendix C for normal battery life spans.

1. Press the **System** key . The current revision number of the software program is displayed. The installer password must then be entered.

**SOFTWARE**  
REV. x.xxx

**ENTER INSTALLER  
PASSWORD: \_ \_ \_ \_**

2. Enter the installer password (0801 by default) and press **Enter** .

**SYSTEM  
PROGRAM AUX'S ▲**

3. Using the up and down-arrow keys   , scroll the menu until the item displayed is PROGRAM AUX'S and press **Enter**  .

**PROGRAM AUX'S**  
**BACKUP BATTERY** 

4. Using the up and down-arrow keys   , scroll the menu until the item displayed is BACKUP BATTERY and press **Enter**  .

**BACKUP BATTERY**  
**12.3 V**

5. If the voltage is less than 10.5 volts, the system displays the warning "LO BATTERY" before displaying the current voltage. The system returns to the Program Aux's scrolling menu.

### 5.3 OUTDOOR TEMPERATURE COMPENSATION ON TEMPERATURE ALARMS



The outdoor temperature compensation feature is only available on AA-800T models.

**Definition:** In situations where the outdoor temperature is high, the room temperature will rise as warm air enters the building through ventilation inlets. If the high set point defined above is not adjusted to take this into account, a high temperature alarm may be needlessly set off. To avoid this situation, the system can compensate for high outdoor temperatures when monitoring temperature alarms. When this feature is activated and the outdoor temperature is close to the high set point, the room temperature is monitored with respect to the outdoor temperature. An alarm is set off only if the room temperature rises above the outdoor temperature by a certain value called the offset. In addition to this, the system also uses a critical high temperature as an absolute limit on room temperature. When room temperature reaches the critical high temperature, an alarm is set off. To use this feature, an outdoor temperature probe must be connected to a temperature zone. The probe must have a pale-colored (white or grey) PVC casing and should be installed near an air intake.

**Critical Temperature:** The absolute temperature limit for room temperatures. When the room temperature reaches this point, an alarm is set off, no matter what the outdoor temperature is.

**Offset:** In general, the room temperature is greater than the outdoor temperature by a certain number of degrees, called the offset. The offset determines when an alarm is set off. It is the number of degrees the room temperature can rise above the outdoor temperature without setting off an alarm.

The diagram below shows when the outdoor temperature compensation feature takes effect (if it has been enabled by the user). When the outdoor temperature is greater or equal to the high set point less the offset, the system uses the outdoor temperature as the reference point for monitoring high temperature alarms.

**Figure 15: Outdoor Temperature Compensation**

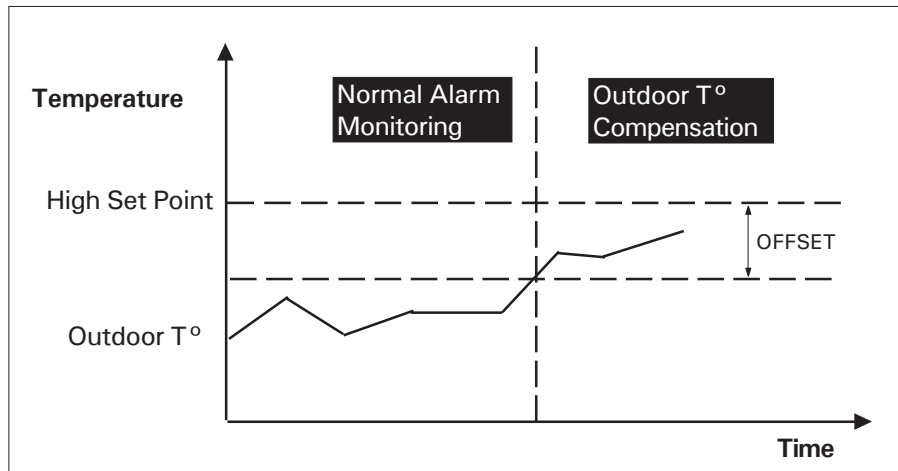



When outdoor temperature compensation is in effect, the system monitors (i) the room temperature with respect to the critical temperature (this check has the highest priority); (ii) the room temperature with respect to the outdoor temperature. The figure below illustrates the first case:

**Figure 16: Critical Temperature Monitoring**

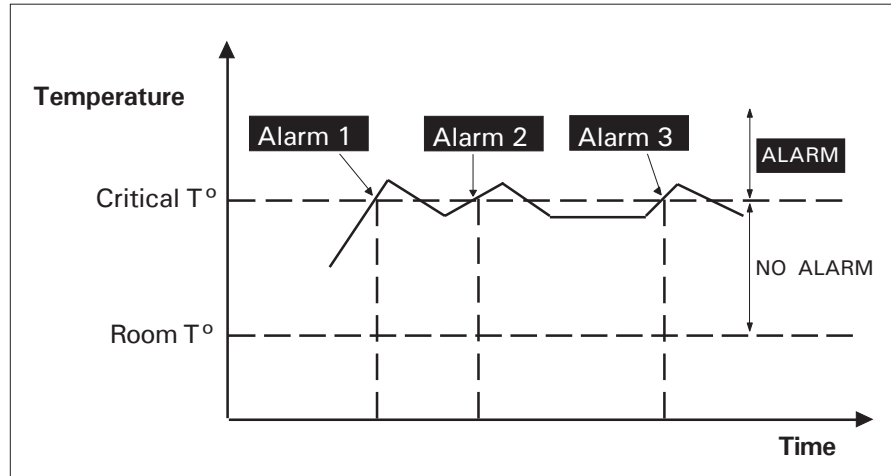

In the second case, the system monitors the difference between the room and outdoor temperatures. When this difference is greater than the offset, an alarm is set off.

**Figure 17: Monitoring the Indoor-Outdoor Temperature Differences**

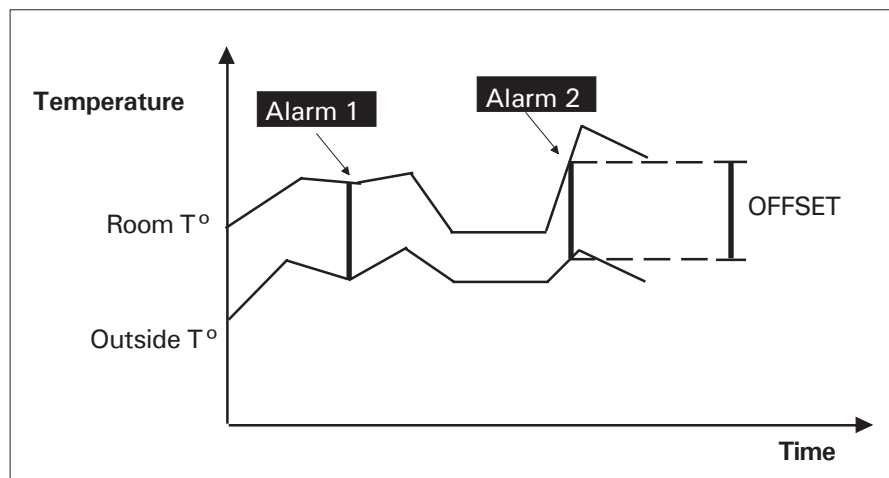

To Make an Outdoor Probe Assignment:

1. Press the **System** key . The current revision number of the software program is displayed. The installer password must then be entered.

**SOFTWARE**  
REV. x.xxx



**ENTER INSTALLER**  
**PASSWORD:** \_ \_ \_ \_

2. Enter the installer password (0801 by default) and press **Enter** .

**SYSTEM**  
**PROGRAM AUX'S** ▲

3. Using the up and down-arrow keys  , scroll the menu until the item displayed is PROGRAM AUX'S and press **Enter** .

**PROGRAM AUX'S**  
**OUTSIDE PROBE** ▼

4. Using the up and down-arrow keys  , scroll the menu until the item displayed is OUTSIDE PROBE and press **Enter** . The message "WARNING! ALARM MEMORY WILL BE LOST!" is displayed. The system prompts for the outdoor probe zone number.

**SELECT ZONE**  
**(1..8):** \_

5. Enter the zone number of the outdoor probe and press **Enter**. By default, zone 8 is assigned to the outdoor probe. If a different zone number was previously defined as the outdoor probe, zone 8 will take the default zone settings. The new probe assignment is displayed and the system returns to the Program Aux's scrolling menu.

**Note:** If, when configuring a zone, the zone selected is the outdoor probe used for the outdoor temperature compensation feature and the compensation feature is currently enabled, the system displays the message: **DEACTIVATE OUTDOOR STATUS**. Use the procedure described above to deactivate the compensation.

To Activate / Deactivate the Outdoor Temperature Compensation (AA-800T Model Only):

1. Press the **Outdoor**  key. The system displays the current status, outdoor probe assignment and temperature offset value.



**OUTDOOR  
PARAMETERS**

**STATUS  
DISABLE**

**OUTDOOR PROBE  
ZONE #8**

**OFFSET TEMP.  
5.0°F**

**TO MODIFY . . . . . (↓)**  
**TO QUIT . . . . . (X)**

2. Press **Enter**  to modify the outdoor temperature compensation settings or **Cancel**  to quit. The system displays a menu.

**STATUS . . . . . (1)**  
**OFFSET TEMP . . . (2)**

3. Type **1** to change the status of the outdoor compensation feature.

**ENABLE . . . . . (1)**  
**DISABLE . . . . . (2)**

4. Type **1** to enable, or **2** to disable outdoor compensation feature. The new setting is displayed and the system returns to the Date/Time display.

To Set the Offset Temperature (AA-800T Model Only):

1. Press the **Outdoor**  key. The system displays the current status, outdoor probe assignment and temperature offset value.



**OUTDOOR  
PARAMETERS**

**STATUS  
DISABLE**

**OUTDOOR PROBE  
ZONE #8**

**OFFSET TEMP.  
5.0°F**

**TO MODIFY . . . . . (↓)**  
**TO QUIT . . . . . (X)**

2. Press **Enter**  to modify the outdoor temperature compensation settings or **Cancel**  to quit.

**STATUS . . . . . (1)**  
**OFFSET TEMP . . . (2)**

3. Type **2** to change the offset temperature. By default, the offset is 5°F (2.8°C).

**RANGE FROM  
(0°F..36°F)**



**OFFSET TEMP.  
\_ \_ \_ \_ °F**

4. Enter the offset temperature and press **Enter**. The system displays the new setting and returns to the Date/Time display.

## 5.4 ALARM MEMORY

**Definition:** Each alarm condition detected by the Agri-Alert system is recorded in memory for future reference. The parameters stored in memory are the zone number, the alarm type, the time, the date, the user who acknowledged the alarm (if a user is defined) and the time and date of acknowledgement. The system stores only the last ten alarms in memory. It should be noted that if the zones are reconfigured at any time, the alarm memory recorded up to that time is erased.

If the password feature is enabled, the system requires a password before acknowledging an alarm from the keypad (acknowledging over the phone always requires a password). This password will appear in the alarm memory listing only if the master password is currently logged onto the system. If a user is logged on, the system will not identify the password that acknowledged the alarm. If, at the time the alarm was acknowledged, the password feature was not enabled, the alarm memory listing will not contain the password that acknowledged the alarm.

To access alarm memory, press the Alarm Memory  key. If no alarm events are presently stored in memory, the system returns the message: **NONE**. To step to the next alarm entry while the current entry is still scrolling on the display, press the Cancel key .

**Examples:** In the first example, the password of the user that acknowledged the alarm is not identified. This means **either** no password was entered when the alarm was acknowledged **or** the current password is not the master password.

**SIREN OUTPUT  
DEFECTED AT 12:47 PM ON AUG 14 2000  
ACK AT 01:16 PM ON AUG14 2000**

In the second example, the password is identified. This means that a password was entered when the alarm was acknowledged **and** the current password is the master password.

**ZONE #1  
HI TEMPERATURE AT 12:47 PM ON AUG 14 2000  
ACK BY 1234 AT 01:16 PM ON AUG14 2000**

## 5.5 ZONE STATUS DISPLAY

**Definition:** You can display zone status information at any time by using the **Zone** key. This key also allows you to modify certain zone parameters such as set points without having to reconfigure the zone. The current zone definition and data readings are displayed along with the zone status. The information displayed depends on the type of zone:

1. Dry contact zones: OPEN / CLOSE, recognition time
2. Temperature zones: temperature reading, set points, critical temperature and recognition time.
3. Pulse count zones: pulse count, set points and observation length

When using the outdoor temperature compensation feature, the zone assigned to the outdoor probe is identified by the message OUTDOOR PROBE (See Section 5.3). The different zone states are summarized below:

1. **DISABLED:** When a zone is first configured, it is in disabled state, until the user activates it using the Activate key. When a zone is disabled, no alarms are detected on the zone input. The zone LED on the front panel is turned off.
2. **ACTIVATED:** Alarm detection is enabled on the zone input. The zone LED on the front panel is turned on. To change the state to BYPASSED, use the Bypass/Activate key.
3. **BYPASSED:** No alarm detection is performed on the zone input. The LED on the front panel blinks slowly. To change the state to ACTIVATED, use the Bypass/Activate key.

### 5.5.1 Viewing and Modifying Dry Contact Zones

The recognition time of a dry contact zone can be modified using the Zone key as follows (refer to section 3.2 for further information about dry contact zones and recognition time).

1. Press the **Zone** key .



**SELECT ZONE**  
**(1 .. 8): \_**

2. Enter the number of a dry contact zone. The state of the zone is displayed, followed by the status.



**ZONE # 5**  
**OPEN**

**ZONE # 5**  
**STATUS : ACTIVATED**

**TO MODIFY . . . . . (↓)**  
**TO QUIT . . . . . (X)**

3. Press Enter to modify the recognition time of the dry contact zone.

**RANGE FROM**  
**(0 .. 59 HR, 0.. 59 MIN, 0 .. 59 SEC)**

**RECOGNITION TIME**  
\_\_ : \_\_ : \_\_

4. Enter the recognition time and press **Enter**. The system displays the new setting and returns to the Date/Time display.

### ***5.5.2 Viewing and Modifying Temperature Zones***

The Zone key allows to modify the set points of temperature zones and their recognition time (refer to section 3.2 for further information about temperature zones and recognition time).

1. Press the **Zone** key .

**SELECT ZONE**  
**(1 .. 8): \_**

2. Enter the number of a temperature zone. The state of the zone is displayed, followed by the status.



**ZONE # 6**  
**75.0°F**

**ZONE # 6**  
**STATUS : ACTIVATED**

**SET POINTS**  
**LO: 55.0 °F,      HI: 85.0 °F**

CRITICAL TEMP.  
95.0 °F

TO MODIFY . . . . . (↓)  
TO QUIT . . . . . (X)

3. The critical temperature is displayed only if the outdoor temperature compensation feature is activated (see Section 5.3) (on AA-800T models only). Press **Enter**  to modify the current set points and/or recognition time or press **Cancel**  to quit.

RECOGNITION . . . (1)  
SET POINTS . . . . . (2)

**Modifying Recognition Time**

4. Press **1** to modify the recognition time.

RANGE FROM  
(0 .. 59 HR, 0.. 59 MIN, 0 .. 59 SEC)

RECOGNITION TIME  
\_\_ : \_\_ : \_\_

5. Enter the recognition time and press **Enter**. The system displays the new setting and returns to the Date/Time display.

**Modifying Temperature Set Points**

4. Press **2** to modify the temperature set points.

TEMPERATURE  
SET POINTS

LO SET POINT

RANGE FROM  
(-40.0°F .. 149.0 °F)



**LO SET POINT**

----- °F

5. This is the lower value of the normal temperature range. It ranges from -40 °F to 149 °F (-40 °C to 65 °C) with an accuracy of 0.1 °F (0.1 °C). Enter the low set point and press **Enter**. To enter a negative value, use the  key, either before or after the digits.

**HI SET POINT**

**RANGE FROM**  
**(X°F .. 149.0 °F)**

**HI SET POINT**

----- °F

6. This is the upper value of the normal temperature range. It ranges from the low set point to 149 °F (65 °C) with an accuracy of 0.1 °F (0.1 °C). Enter the high set point and press **Enter**. To enter a negative value, use the  key, either before or after the digits. The high set point must be greater than the low set point.

**CRITICAL TEMP.**

**RANGE FROM**  
**(X°F .. 149.0 °F)**

**CRITICAL TEMP.**

----- °F

7. The critical temperature is displayed only if the outdoor temperature compensation feature is activated (see Section 5.3) (on AA-800T model only). It is the absolute temperature limit for room temperatures. It is used in conjunction with the outdoor temperature compensation feature. When the room temperature reaches this point and the outdoor temperature compensation feature is enabled, an alarm is set off, no

matter what the outdoor temperature is. It ranges from the high set point to 149 °F (65 °C) with an accuracy of 0.1 °F (0.1 °C). Enter the critical temperature and press **Enter**. To enter a negative value, use the +/- key, either before or after the digits. The system displays the current zone temperature and returns to the Date/Time display.

### 5.5.3 Viewing and Modifying Pulse Count Zones

The Zone key allows to modify the lo and hi set points of pulse count zones. It is also possible to change the observation length. Refer to section 3.2 for further information about pulse count zones.

1. Press the **Zone** key Zone.

**SELECT ZONE**  
**(1 .. 8):** \_

2. Enter the number of a pulse count zone. The state of the zone is displayed, followed by the status.

**ZONE # 7**  
**10 PULSES**

**ZONE # 7**  
**STATUS : ACTIVATED**

**SET POINTS**  
**LO:3 PULSES, HI:15 PULSES**

**OBSERVATION LENGTH**  
**00 : 05 : 30**

**TO MODIFY . . . . . (↵)**  
**TO QUIT . . . . . (X)**

3. Press **Enter** to modify the pulse count zone set point and observation length.

**PULSE COUNT**  
**PULSE SET POINT**

**RANGE FROM**  
**(0 .. 254)**

**LO SET POINT**  
**\_\_\_ PULSES**

4. This is the lower number of pulses allowable during the observation length. It ranges from 0 to 254. Enter the low set point and press **Enter**.

**HI SET POINT**  
**\_\_\_ PULSES**

5. This is the highest number of pulses allowable during the observation length. It ranges from 0 to 254. Enter the high set point and press **Enter**.

**OBSERVAT. LENGTH**

**RANGE FROM**  
**(0 .. 59HR, 0 .. 59MIN, 0 ..59 SEC)**

**OBSERVAT. LENGTH**  
**\_\_ : \_\_ : \_\_**

6. Enter the observation length and press **Enter**. The system displays the new setting and returns to the Date/Time display.



## 5.6 PARTITIONS

**Definition:** Zones can be grouped into partitions, relating alarm systems located in the same area. This makes it easy to activate or bypass several zones at once, if they are physically located in the same area or if they are logically connected together. Figure 18 below gives an example of this. If, for example, the animals in Building 2 are evacuated, the alarm systems for the entire building can be turned off at once. Up to 8 different partitions can be programmed into the system. If changes are made to a partition, all zones associated with the partition are deactivated. Note that burglar zones cannot be included in a partition. If a zone belonging to a partition is redefined as a burglar zone, it will be removed from the partition.

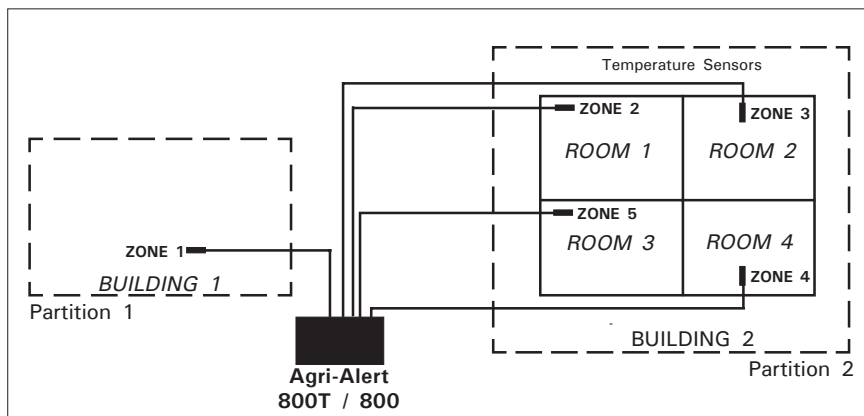
**Figure 18: Example of Partitioning**



### Setting:

- Press the **Partitions** key . The partitions currently stored in memory are displayed. To stop the display, press the **Cancel** key .

TO MODIFY..... (↓)  
TO QUIT..... (X)



- Press **Enter**  to modify.

ENTER PARTITION  
(1 .. 8): \_

- Type the number of the partition to modify and press **Enter**.

Adding a zone:

```
PARTITION #1
ADD ZONE? ▼
```

3. The different options are presented in a scrolling menu. Use the up and down arrow keys   to select ADD ZONE and press **Enter**.



```
#1) 1, 2, 3
ADD ZONE: _
```

4. The zones currently included in the partition are displayed on the first line. Enter the number of the zone to add to the partition and press **Enter**. If you choose a zone that is already assigned to another partition, the system responds with the message: **ZONE IS ALREADY SELECTED**. The system displays the new partition definition.

```
PARTITION #1
ZONE #1, 2, 3, 4
```

Deleting a zone:

```
PARTITION #1
DEL ZONE? ▲▼
```

3. The different options are presented in a scrolling menu. Use the up and down arrow keys   to select DEL ZONE and press **Enter**.



```
#1) 1, 2, 3, 4
DEL ZONE: _ _
```

4. Enter the number of the zone to delete from the partition and press **Enter**. The system displays the new partition definition.

```
PARTITION #1
ZONE #1, 2, 3
```

Deleting a partition:

PARTITION #1  
DEL PARTITION ? ▲

3. The different options are presented in a scrolling menu. Use the up and down arrow keys   to select DEL PARTITION and press **Enter**. The system displays the message **PARTITION DELETED**.

After making a change:

The system prompts to make more changes or to end the session:

TO CONTINUE. . . .(1)  
TO END . . . . . (2)

Type **1** to make more changes. Type **2** to exit this function; the system returns to the Date/Time display.

## 5.7 BYPASS / ACTIVATE FUNCTION

**Definition:** The Agri-Alert system can activate or bypass individual zones and partitions. When a zone is bypassed, no alarm detection is performed on the zone input. When a zone becomes active, the corresponding LED on the left hand side of the front panel turns on and the system monitors the alarm input connected to the zone. When an alarm occurs, the LED for the zone where an alarm was detected starts blinking rapidly. The relevant data are recorded in alarm memory and the dialout sequence is launched. Note that burglar zones cannot be activated in this way although they can be bypassed one zone at a time. These zones are activated with the dot key and a password.

**Setting:**

To change the status of a zone:

1. Press the **Bypass / Activate**  key.

**ZONE . . . . . (1)**  
**PARTITION . . . . . (2)**

2. Type **1** to change the status of a zone;

**ENTER ZONE**  
**(1 .. 8): \_**

3. Type the number of the zone and press **Enter**. If the zone is not properly configured, the system responds with the message: **INCOMPLETE DATA**.

**ACTIVATE . . . . .(1)**  
**BYPASS . . . . . (2)**

4. Type **1** to activate, or **2** to bypass the zone. The new state of the zone is displayed. If you have just activated a zone, the LED associated with the zone will turn on.

To change the status of a partition:

1. Press the **Bypass / Activate**  key.

**ZONE . . . . . (1)**  
**PARTITION . . . . . (2)**

2. Type **2** to change the status of a partition.

**ENTER PARTITION**  
**(1 .. 8): \_**

3. Type the number of the partition and press **Enter**. If the partition does not exist, the system responds with the message: **PARTITION NONE**.

**ACTIVATE . . . . . (1)**  
**BYPASS . . . . . (2)**

4. Type **1** to activate or **2** to bypass the partition. The new state of the zone is displayed. If you have activated a partition, all the LEDs associated with the zones in the partition turn on.

## 5.8 ENTRY DELAY

**Definition:** The time needed to disarm the burglar zones when entering the site before an alarm is set off. This applies to all burglar zones and ranges from 0 to 5 minutes, 0 to 59 seconds. The default is 30 seconds. The entry delay countdown begins when an alarm is detected in a burglar zone with an entry delay.

### Setting:



1. Press the **Entry/Exit Delay** key .

ENTRY DELAY. . . . .(1)  
EXIT DELAY . . . . . (2)

2. Type 1 to adjust the entry delay.

ENTRY DELAY  
0 MIN, 30 SEC

TO MODIFY. . . . . (↵)  
TO QUIT. . . . . (X)

3. Press **Enter**  to adjust the entry delay or **Cancel**  to quit.

RANGE FROM  
(0 .. 5 MIN, 0 .. 59 SEC)

ENTER NEW DELAY  
\_ MIN : \_ \_ SEC

4. Enter the new delay and press **Enter**. The system displays the new setting and returns to the Date/Time display.



## 5.9 EXIT DELAY

**Definition:** The time needed to exit the site before the system starts monitoring the alarm inputs. This applies only to burglar zone and is common to all zones. It ranges from 0 to 5 minutes, 0 to 59 seconds. The default is 30 seconds.

### Setting:

1. Press the **Entry/Exit Delay** key .

ENTRY DELAY . . . . . (1)  
EXIT DELAY . . . . . (2)

2. Type **2** to adjust the exit delay.

EXIT DELAY  
0 MIN, 30 SEC

TO MODIFY . . . . . (↵)  
TO QUIT . . . . . (X)

3. Press **Enter**  to adjust the exit delay or **Cancel**  to quit.

RANGE FROM  
(0 .. 5 MIN, 0 .. 59 SEC)

ENTER NEW DELAY  
\_ MIN : \_ \_ SEC

4. Enter the new delay and press **Enter**. The system displays the new setting and returns to the Date/Time display.

## 5.10 SIREN DELAY

**Definition:** When an alarm condition is detected, and if the siren is enabled for the zone in alarm, the system activates the siren. This parameter defines the time the siren will sound. The value ranges from 1 to 20 minutes. The default is 5 minutes.

### Setting:

1. Press the **Siren Delay** key . The current siren delay is displayed.

5 MIN

TO MODIFY..... (↵)  
TO QUIT..... (X)

2. Press **Enter** .

RANGE FROM  
(1 .. 20 MIN)

ENTER NEW DELAY  
\_ \_ MIN

3. Enter the new delay and press **Enter**. The system returns to the Date/Time display.

## TROUBLESHOOTING GUIDE

PROBLEM	SOLUTIONS
The ALARM LED always turns on.	<p>1- Check Alarm Memory to determine which fuse is blown. Refer to the table in Appendix A for replacement specifications. If the problem is with the siren fuse, follow the steps below:</p> <p>2- Check the siren fuse (F8). If fuse is blown, try to determine why before replacing. Do not increase fuse capacity - this could be a fire hazard. Remember that the reset time is 45 minutes if no one is present and 2 minutes if someone is present.</p> <p>3- If no siren is connected to the siren terminals, a resistor must be connected in its place (1.5k<math>\Omega</math>, 1/2W). See the intallation manual (section 1.3.3.1).</p> <p>4- If the siren impendance is to high, add a 1.5k<math>\Omega</math>, 1/2W resistor to the siren cicruit, as close to the siren as possible.</p> <p>5- The siren wire or siren may be defective.</p> <p>6- If the problem persists, contact your dealer.</p>
The TROUBLE LED turns on.	<p>1- Press the TROUBLE key for more information. Fix the problem if possible and choose ERASE in the menu to reset the trouble flag.</p> <p>2- If the problem persists, contact your dealer.</p>
The 16 VAC FAILURE LED turns on and electrical power is OK.	<p>1- Check fuses F6 and F7. If fuse is blown, try to determine why before replacing. Do not increase fuse capacity - this could be a fire hazard.</p> <p>2- Check the wall transformer and wiring.</p> <p>3- Use a voltmeter to check voltage at the 16 VAC input terminals (16VAC minimum).</p> <p>4- If the problem persists, contact your dealer.</p>

<b>PROBLEM</b>	<b>SOLUTIONS</b>
The LOW BATTERY LED turns on and electrical power is OK.	<p>1- Remember that the reset time is 45 minutes; the counter is started only once the display backlight turns off.</p> <p>2- Check battery voltage by pressing the System key and selecting BACKUP BATTERY from the Program Aux's menu. Normal voltage should read from 12V to 14V.</p> <p>3- Check fuse F28. If fuse is blown, try to determine why before replacing. Do not increase fuse capacity - this could be a fire hazard.</p> <p>4- Check the wall transformer and wiring.</p> <p>5- Use a voltmeter to check voltage at the 16VAC input terminals (16VAC minimum).</p> <p>5- Check the wiring to the battery.</p> <p>6- If the problem persists, contact your dealer.</p>
System goes into Standby mode by itself.	Disable standby mode (using the On/Off key). Check battery voltage by pressing the System key and selecting BACKUP BATTERY from the Program Aux's menu. Normal voltage should read from 12V to 14V. If the voltage is low, follow instructions above for 16 VAC failure led.
The message DISTURBED LINE is displayed when the system dials out.	If your system has not been wired for line seizure, try enabling the line seizure function by pressing the System key and selecting LINE SEIZURE from the menu (section 4.1.2 of the installation manual). This will deactivate the off-hook monitor test.
Phone line does not behave as expected.	Unplug the Agri-Alert system phone plug from the wall jack and contact your dealer.

## APPENDIX A: FUSE TYPES

FUSE NUMBER	FUSE TYPE	FONCTION
F4	1A fast blow 5 x 20 mm	12VDC Output
F6,F7	5A fast blow 5 x 20 mm	AC Power Connection
F8	2A slow blow 5 x 20 mm	Siren Output
F28	5A slow blow 5 x 20 mm	Back-up Battery

## APPENDIX B: MAXIMUM WIRE LENGTHS

WIRE TYPE	TEMPERATURE PROBE	OTHER PROBES	SIREN / 12VDC OUTPUT
#16 AWG	250 m (820')	2000 m (6560')	50 m (164')
#18 AWG	125 m (410')	1300 m (4265')	30 m (98')
#20 AWG	62 m (205')	800 m (2624')	N.A.
#22 AWG	31 m (102')	500 m (1640')	N.A.

## APPENDIX C: BACKUP BATTERY LIFE SPAN

CURRENT (mA)	TEMPERATURE	
	0°C / 32°F	20°C / 68°F
350mA minimum charge Siren and 12VCD output not used	17 hours	20 hours
3500mA maximum charge Siren - 1500mA 12VCD - 750mA	1/2 hour	1 hour

## GLOSSARY OF TERMS

**ACKNOWLEDGEMENT:** The indication to the system that an alarm message has been received. The alarm acknowledgement stops the dialout sequence and can be executed over the phone or from the keypad.

**ALARM MEMORY:** A record of the ten last alarms stored by the system (see Section 5.4).

**BREAK:** On pulse dialing lines, the length of the open circuit portion of the pulse period (see Section 4.1.1.3).

**BURGLAR ZONE:** A zone used for detecting break-ins. Delays are provided to allow authorized entries and exits. All burglar zones are armed or disarmed as a group using a special key sequence (see Section 3.2.2).

**BUSY TRIES:** In the dialout sequence, the number of times the system will retry a number when the line is busy. (see Section 4.1.5).

**CALL START DELAY:** The time between the validation of an alarm and the beginning of the dialout sequence (see Section 4.1.8).

**CALL REPETITIONS:** In the dialout sequence, the number of times the phone numbers in memory are called for a given alarm (See Section 4.1.3).

**DEFAULT:** A value permanently stored in memory and used to define a parameter in the absence of a user-defined value (see Section 3.7).

**DIALOUT SEQUENCE:** Upon validation of an alarm, the calling of the phone numbers in memory according to a specified order until each number is reached a specified number of times (see Section 4.1).

**DTMF SPEED (Dual Tone Multiple Frequency Speed):** The dialing speed used on tone dialing lines (see Section 4.1.1.2).

**EOLR (End Of Line Resistor):** A resistor added to an alarm circuit and used for detecting wire problems (see Section 3.2.1).

**ENTRY DELAY:** The time delay for entering the site without setting off an alarm (see Section 5.8).

**EXIT DELAY:** The time delay for exiting the site without setting off an alarm (see Section 5.9). This applies to burglar zones only.

**INTERDIGIT INTERVAL:** On pulse dialing lines, the length of the interval between each digit (see Section 4.1.1.3).

**LED:** Light Emitting Diode — An electronic device used to indicate the status of various functions on the front panel.

**MAIN BOARD:** The electronic card located at the bottom of the Agri-Alert enclosure (marked V-101) (see Section 1.2.1).

**MAKE:** On pulse dialing lines, the length of the closed circuit portion of the pulse period (see Section 4.1.1.3).

**MESSAGE REPETITIONS:** The number of times a voice message is delivered when an alarm condition is reported (See Section 4.1.4).

**NORMALLY CLOSED DEVICE:** A device that triggers an alarm by opening a closed circuit path (see Section 3.2.1).

**NORMALLY OPEN DEVICE:** A device that triggers an alarm by closing an open circuit path (see Section 3.2.1).

**PARTITION:** A group of zones used for activating or bypassing several zones at once (see Section 5.6).

**PULSE SPEED:** This is the dialing speed used on pulse dialing lines, consisting of a make, a break and an interdigit interval (see Section 4.1.1.3).

**ALARM RECALL TIME:** The length of time between the time the alarm is acknowledged and the time the dialout sequence is relaunched (as long as the zone has not returned to its normal state for the duration of reset time (see Section 4.1.10).

**SENSOR:** A device connected to the Agri-Alert used to detect alarm conditions (see Section 1.3.1).

**SIREN DELAY:** The duration of the siren when an alarm condition is reported (see Section 5.10).

**TIME BETWEEN CALLS:** In the dialout sequence, the delay after a phone number has been called, before proceeding with the next number (see Section 4.1.9).

**ZONE:** An input configured to respond to the sensor connected to it (See Section 3.2).

# WIRING DIAGRAMS

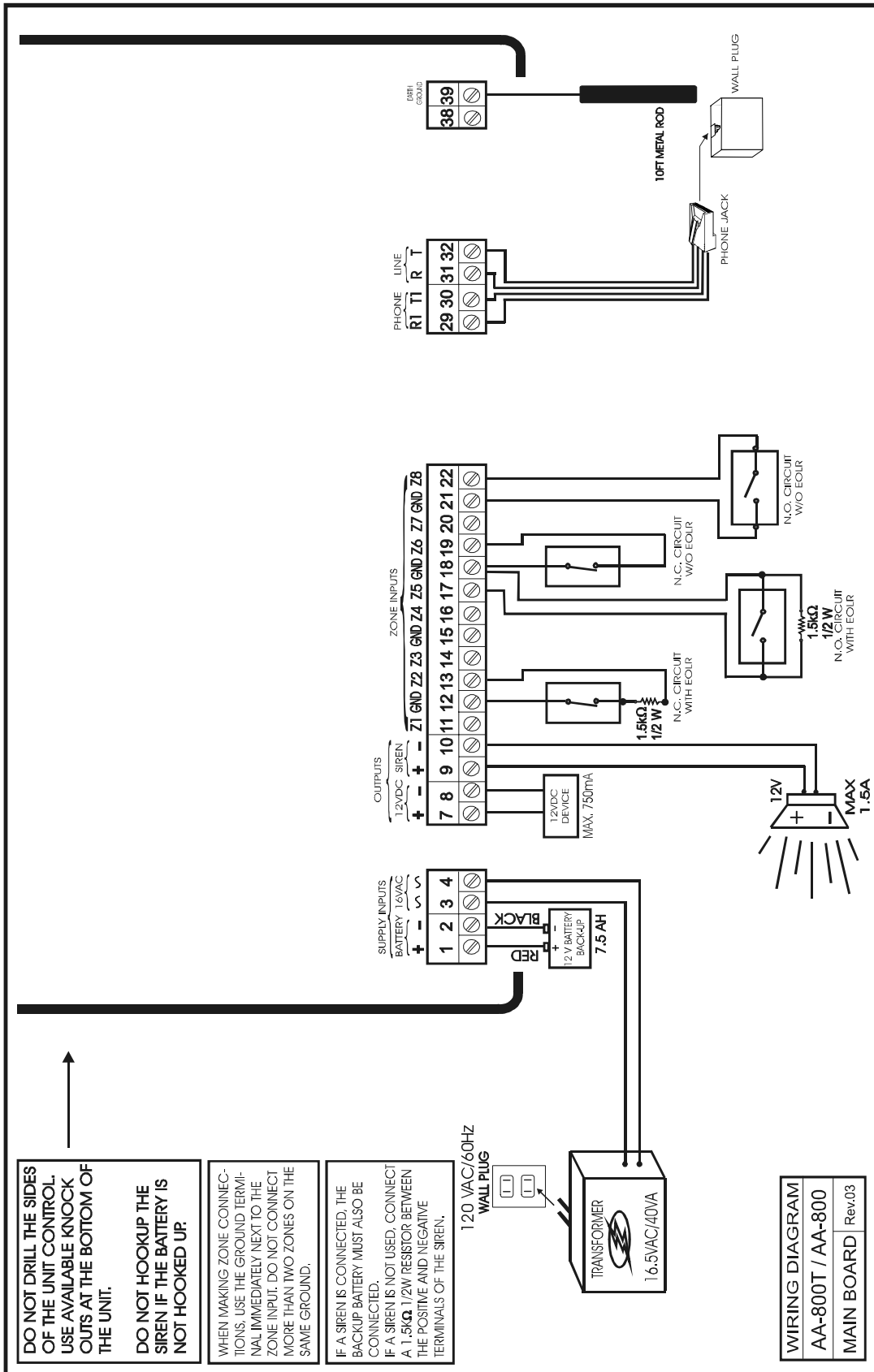



## TECHNICAL SPECIFICATIONS

**TYPE:** AA800 & AA800T

**- SUPPLY:**

Transformer: 16.5 VAC, 40 VA  
Fuse F6-5A fast blow  
Fuse F7-5A fast blow

Battery: Rechargeable, sealed, lead-acid, 12V / 7.5 AH  
Fuse F28-5A slow blow

**- OUTPUTS:**

Siren : 12VDC, 1.5A max. Fuse F8-2A slow blow.

12VDC Output : 750mA DC max. Fuse F4-1A fast blow (AA800T models only)

**- OPERATING TEMPERATURE:** 32 TO 104°F (0 TO 40°C) Indoor use only

**- POLLUTION DEGREE :** 2

**- INSTALLATION CATEGORY:** 2

**- ALTITUDE:** 7900 Ft.Max (2000 Meters Max)

**- HUMIDITY:** 95% max.

**- CLEANING:** Gentle soap and water.



REGISTRATION CARD

**AGRI-ALERT 800 & AGRI-ALERT 800T**

**Please fill out the following form to receive information on future updates.**

Name: \_\_\_\_\_

Address : \_\_\_\_\_

City: \_\_\_\_\_

Phone number: \_\_\_\_\_

Fax number: \_\_\_\_\_

E-mail: \_\_\_\_\_

Purchased from: \_\_\_\_\_

Date purchased: \_\_\_\_\_

Serial Number: \_\_\_\_\_

Software Version Number: \_\_\_\_\_  
(Press the System key)

**Fax this page to: (450) 926-2780**